

Construction Stormwater General Permit (CSWGP)

# Stormwater Pollution Prevention Plan (SWPPP)

for

**Huber Residence**

Prepared for:

**City of Mercer Island / Department of Ecology**  
*Northwest Regional Office*

<b>Permittee / Owner</b>	<b>Developer</b>	<b>Operator / Contractor</b>
Mike and Elizabeth Huber	Mike and Elizabeth Huber	Hamish Anderson Custom Homes, Inc.

**Project Site Location:** 9611 SE 72<sup>nd</sup> Street, Mercer Island WA 98040, Parcel No. 3575304875

### General Contractor

<b>Name</b>	<b>Organization</b>	<b>Contact Phone Number</b>
Hamish Anderson	Hamish Anderson Custom Homes, Inc.	425.576.1923

### Certified Erosion and Sediment Control Lead (CESCL)

<b>Name</b>	<b>Organization</b>	<b>Contact Phone Number</b>
TBD	TBD	TBD

### SWPPP Prepared By

<b>Name</b>	<b>Organization</b>	<b>Contact Phone Number</b>
Brady Berriman, PE	Latitude 48, P.S.	206-556-1615

### SWPPP Preparation Date

September 13, 2021

### Project Construction Dates

<b>Activity / Phase</b>	<b>Start Date</b>	<b>End Date</b>
General Construction	TBD	TBD

## List of Acronyms and Abbreviations

<b>Acronym / Abbreviation</b>	<b>Explanation</b>
<b>303(d)</b>	Section of the Clean Water Act pertaining to Impaired Waterbodies
<b>BFO</b>	Bellingham Field Office of the Department of Ecology
<b>BMP(s)</b>	Best Management Practice(s)
<b>CESCL</b>	Certified Erosion and Sediment Control Lead
<b>CO<sub>2</sub></b>	Carbon Dioxide
<b>CRO</b>	Central Regional Office of the Department of Ecology
<b>CSWGP</b>	Construction Stormwater General Permit
<b>CWA</b>	Clean Water Act
<b>DMR</b>	Discharge Monitoring Report
<b>DO</b>	Dissolved Oxygen
<b>Ecology</b>	Washington State Department of Ecology
<b>EPA</b>	United States Environmental Protection Agency
<b>ERO</b>	Eastern Regional Office of the Department of Ecology
<b>ERTS</b>	Environmental Report Tracking System
<b>ESC</b>	Erosion and Sediment Control
<b>GULD</b>	General Use Level Designation
<b>NPDES</b>	National Pollutant Discharge Elimination System
<b>NTU</b>	Nephelometric Turbidity Units
<b>NWRO</b>	Northwest Regional Office of the Department of Ecology
<b>pH</b>	Power of Hydrogen
<b>RCW</b>	Revised Code of Washington
<b>SPCC</b>	Spill Prevention, Control, and Countermeasure
<b>su</b>	Standard Units
<b>SWMMEW</b>	Stormwater Management Manual for Eastern Washington
<b>SWMMWW</b>	Stormwater Management Manual for Western Washington
<b>SWPPP</b>	Stormwater Pollution Prevention Plan
<b>TESC</b>	Temporary Erosion and Sediment Control
<b>SWRO</b>	Southwest Regional Office of the Department of Ecology
<b>TMDL</b>	Total Maximum Daily Load
<b>VFO</b>	Vancouver Field Office of the Department of Ecology
<b>WAC</b>	Washington Administrative Code
<b>WSDOT</b>	Washington Department of Transportation
<b>WWHM</b>	Western Washington Hydrology Model

## **Project Information (1.0)**

Project/Site Name: Huber Residence  
Street/Location: 9611 SE 72<sup>nd</sup> Street, Mercer Island 98040, Parcel No. 957950-0040  
City: Mercer Island State: WA Zip code: 98040  
Subdivision: N/A  
Receiving waterbody: Lake Washington

## **Existing Conditions (1.1)**

Total acreage (including support activities such as off-site equipment staging yards, material storage areas, borrow areas).

Total acreage: 0.37 Acres (16,175 SF)

Disturbed acreage: 0.25 Acres (10,890 SF)

Existing structures: Existing Residence

Landscape topography: The site slopes down towards the west at slopes of about 10% to 50%. There are critical slopes of greater than 40% on the site (far west portion of the project site), outside of the proposed development.

Drainage patterns: The site slopes mildly from west to east towards Lake Washington and stormwater is collected in a series of catch basin and area drains. Water is conveyed east towards an existing outfall located in the bulkhead along the lake edge. Per the project survey, three (3) stormwater stubs are located at the outfall to discharge all site stormwater. There are no detention, water quality or LID facilities currently on the project site to be maintained, protected or replaced.

The project owner and contractor have noted some groundwater discharge coming from the existing hillside to the west. This project proposes to capture this water before heading east to the proposed home by use of a French drain behind the proposed retaining wall and a series of catch basins.

Existing Vegetation: The site includes several trees, some of which will be removed as part of the development and others that are currently decaying (per site arborist).

Critical Areas (wetlands, streams, high erosion risk, steep or difficult to stabilize slopes): Steep Slopes Hazard area (slopes in excess of 40%).

List of known impairments for 303(d) listed or Total Maximum Daily Load (TMDL) for the receiving waterbody: Lake Washington (directly adjacent to our project) is listed by Washington State Department of Ecology as a Category 2 water body for PCBs, and Category 1 water body for Bacteria – Fecal coliform, Phosphorus, and Bacteria – Escherichai coli. See Appendix F.

**Table 1 – Summary of Site Pollutant Constituents**

<b>Constituent (Pollutant)</b>	<b>Location</b>	<b>Depth</b>	<b>Concentration</b>
None			

## **Proposed Construction Activities (1.2)**

### Description of site development: General Site Development for Single Family Residence

Description of construction activities: The proposed project consists of site development associated with the single-family building permit. Construction activities will include clearing, excavation, shoring installation of utilities, and construction to support the single-family residence.

Description of site drainage including flow from and onto adjacent properties: Under developed conditions, stormwater from proposed site improvements will be collected and conveyed west to discharge directly into Lake Washington.

Description of final stabilization: Final stabilization will include site landscaping and paving.

Contaminated Site Information: No contaminated soils have been identified on the site.

Proposed activities regarding contaminated soils or groundwater: Potential groundwater noted by contractor and owner in NW corner of project site. Temporary groundwater mitigation strategies and pumping may be required to install permanent shoring wall on west portion of the project site. French drain will be installed behind wall to reroute any ground water away from proposed building and ultimately discharge into Lake Washington.

Monitoring: Turbidity monitoring will occur at the end of the proposed stormwater system, prior to reaching the existing stormwater main, as identified on the project site plan. Monitoring will be conducted in accordance with Section 4.0 and requirements of the CSWGP.

## **Construction Stormwater Best Management Practices (BMPs) (2.0)**

### **The 12 Elements (2.1)**

#### **Element 1: Preserve Vegetation / Mark Clearing Limits (2.1.1)**

The construction limits will be delineated by a high visibility orange fence or silt fence with orange fabric. The fence will provide clear and physical limits for construction.

List and describe BMPs:

BMP C103: High Visibility Plastic or Metal Fence

BMP C233: Silt Fence (Double silt fence will be installed upstream of onsite wetlands)

Installation Schedules: Prior to clearing

Inspection and Maintenance plan:

- Weekly inspection, maintain as needed to allow proper functioning of structures.
- Any damage shall be repaired immediately. If concentrated flows are evident uphill of the fence, they must be intercepted and conveyed to a sediment pond.
- It is important to check the uphill side of the fence for signs of the fence clogging and acting as a barrier to flow and then causing channelization of flows parallel to the fence. If this occurs, replace the fence or remove the trapped sediment.
- Sediment deposits shall either be removed when the deposit reaches approximately one-third the height of the silt fence, or a second silt fence shall be installed.

Responsible Staff: Contractor

## **Element 2: Establish Construction Access (2.1.2)**

A single construction entrance will be used to access the site for construction traffic. Construction access to the site will be directly off 211th Avenue NE.

List and describe BMPs:

BMP C105: Stabilized Construction Entrance

BMP C107: Construction Road/Parking Stabilization

Installation Schedules: Initial construction stage, prior to grading

Inspection and Maintenance plan:

- Inspect stabilized areas regularly, especially after large storm events.
- If the entrance is not preventing sediment from being tracked onto pavement, then alternative measures to keep the streets free of sediment shall be used. This may include street sweeping, an increase in the dimensions of the entrance, or the installation of a wheel wash.
- Any sediment that is tracked onto pavement shall be removed by shoveling and/or street sweeping. The sediment collected by sweeping shall be removed or stabilized on site. The pavement shall not be cleaned by washing down the street, except when sweeping is ineffective and there is a threat to public safety. If it is necessary to wash the streets, the construction of a small sump shall be considered. The sediment would then be washed into the sump where it can be controlled.
- Any quarry spalls that are loosened from the pad, which end up on the roadway shall be removed immediately.
- Crushed rock, gravel base, hog fuel, etc. shall be added as required to maintain a stable driving surface and to stabilize any areas that have eroded.

Responsible Staff: Contractor

### **Element 3: Control Flow Rates (2.1.3)**

Construction stormwater will be detained onsite in a sediment tank (Baker Tank) and discharge to the existing storm main system to the south.

Will you construct stormwater retention and/or detention facilities?

Yes **No**

Will you use permanent infiltration ponds or other low impact development (example: rain gardens, bio-retention, porous pavement) to control flow during construction?

Yes **No**

List and describe BMPs:

BMP C200: Interceptor Dikes and Swales

BMP C209: Outlet Protection

BMP C233: Silt Fence

BMP C240: Sediment Trap

Installation Schedules: Prior to grading

Inspection and Maintenance plan:

- Repair and replace rock as necessary.
- Remove sediment when 30 percent of structure capacity is filled. Inspect and repair as needed.
- Add rock as needed to maintain the intended function.
- Clean energy dissipater if sediment builds up.

Responsible Staff: Contractor

## **Element 4: Install Sediment Controls (2.1.4)**

Silt fence has been specified at locations on the work boundaries where runoff has the potential to leave the project site. Temporary Straw wattles will be a key element in collecting construction runoff and sediment prior to discharging into the site outfall into Lake Washington

List and describe BMPs:

BMP C220: Storm Drain Inlet Protection

BMP C233: Silt Fence

BMP C235: Wattles

BMP C235: Sediment Trap (If required)

Due to proximity to Lake Washington, a temporary sediment trap (or Baker Tank) may also be required to capture and storm stormwater prior to discharging into Lake Washington. If during construction the contractor needs additional measures to mitigate sediment discharges from the site, contact the engineer to help size a temporary baker tank.

Inspection and Maintenance plan:

- Any damage shall be repaired immediately. If concentrated flows are evident uphill of the fence, they must be intercepted and conveyed to a sediment pond.
- It is important to check the uphill side of the fence for signs of the fence clogging and acting as a barrier to flow and then causing channelization of flows parallel to the fence. If this occurs, replace the fence or remove the trapped sediment.
- Sediment deposits shall either be removed when the deposit reaches approximately one-third the height of the silt fence, or a second silt fence shall be installed

Responsible Staff: Contractor



## Element 5: Stabilize Soils (2.1.5)

Disturbed soils will be stabilized with appropriate measures. The exact BMP will depend upon the final configuration of that portion of the site and the phase of construction. Areas that will ultimately become landscape will be seeded and mulched once they reach their final grade and configuration.

The area of clearing will be limited where possible to minimize the amount of exposed soil surfaces, and the potential of erosion and sedimentation impacts on surface water. Temporary and permanent cover measures will be provided to protect disturbed areas. Mulching will be used to provide immediate temporary protection from erosion and to enhance plant growth. Plastic covering will be used to cover soil stockpiles and trench excavations, and to protect steep slopes behind wall construction, stockpiles or to encourage grass growth in newly seeded areas.

The contractor should consider using a more durable geomembrane material in lieu of plastic for covering soil stockpiles. A more durable material will perform better and can be re-used several times over the life of the project. Dust control will be implemented as needed. All of these features will be maintained throughout the construction effort.

From October 1 through March 31, no soils shall remain exposed and unworked for more than 2 days. From April 1 to September 30, no soils shall remain exposed and unworked for more than 7 days. This stabilization requirement applies to all soils on site, whether or not at final grade.

Season	Dates	Number of Days Soils Can be Left Exposed
During the Dry Season	May 1 – September 30	7 days
During the Wet Season	October 1 – April 30	2 days

Soils must be stabilized at the end of the shift before a holiday or weekend if needed based on the weather forecast.

Anticipated project dates: Start date: TBD End date: TBD

Will you construct during the wet season?

Yes No

List and describe BMPs:

- BMP C120: Temporary and Permanent Seeding
- BMP C121: Mulching
- BMP C122: Nets and Blankets
- BMP C123: Plastic Covering
- BMP C130: Surface Roughening
- BMP C140: Dust Control

Installation Schedules: During site grading

## Inspection and Maintenance plan:

### *Temporary and Permanent Seeding*

- Any seeded areas that fail to establish at least 80 percent cover (100 percent cover for areas that receive sheet or concentrated flows) shall be reseeded. If reseeding is ineffective, an alternate method, such as sodding, mulching, or nets/blankets, shall be used. If winter weather prevents adequate grass growth, this time limit may be relaxed at the discretion of the local authority when sensitive areas would otherwise be protected.
- After adequate cover is achieved, any areas that experience erosion shall be reseeded and protected by mulch. If the erosion problem is drainage related, the problem shall be fixed and the eroded area reseeded and protected by mulch.
- Seeded areas shall be supplied with adequate moisture, but not watered to the extent that it causes runoff.

### *Mulching*

- The thickness of the cover must be maintained.
- Any areas that experience erosion shall be re-mulched and/or protected with a net or blanket. If the erosion problem is drainage related, then the problem shall be fixed and the eroded area re-mulched.

### *Nets and Blankets*

- Good contact with the ground must be maintained, and erosion must not occur beneath the net or blanket.
- Any areas of the net or blanket that are damaged or not in close contact with the ground shall be repaired and stapled. If erosion occurs due to poorly controlled drainage, the problem shall be fixed and the eroded area protected.

### *Plastic Covering*

- Torn sheets must be replaced and open seams repaired.
- If the plastic begins to deteriorate due to ultraviolet radiation, it must be completely removed and replaced.
- When the plastic is no longer needed, it shall be completely removed.

### *Surface Roughening*

- Areas that are graded in this manner should be seeded as quickly as possible.
- Regular inspections should be made of the area. If rills appear, they should be re-graded and re-seeded immediately.

### Dust Control

- Re-spray area with water as necessary to keep dust to a minimum.

Responsible Staff: Contractor

## **Element 6: Protect Slopes (2.1.6)**

Nets and blankets, seeding, and surface roughening may be used to stabilize embankments.

Will steep slopes be present at the site during construction?

Yes            No

List and describe BMPs:

BMP C120: Temporary and Permanent Seeding

BMP C121: Mulching

BMP C122: Nets and Blankets

BMP C130: Surface Roughening

Installation Schedules: During grading

Inspection and Maintenance plan: See Element 5

Responsible Staff: Contractor

## **Element 7: Protect Drain Inlets (2.1.7)**

Existing drainage structures may collect surface runoff within the project area if constructed prior to other improvements. Sediment should not be allowed to enter any of these structures. Filter fabric or socks will be placed on or in the inlets.

List and describe BMPs:

BMP C220: Storm Drain Inlet Protection

Installation Schedules: Prior to grading

Inspection and Maintenance plan:

- Inlets will be inspected weekly at a minimum and daily during storm events.
- Inlet protection devices will be cleaned (or removed and replaced), when sediment has filled the device by one third (1/3) or as specified by the manufacturer.
- Do not wash sediment into storm drains while cleaning. Spread all excavated material evenly over the surrounding land area or stockpile and stabilize as appropriate.

Responsible Staff: Contractor

## **Element 8: Stabilize Channels and Outlets (2.1.8)**

Provide stabilization, including armoring material, adequate to prevent erosion of outlets, adjacent stream banks, slopes, and downstream reaches, will be installed at the outlets of all conveyance systems.

List and describe BMPs:

- BMP C202: Channel and Lining
- BMP C207: Check Dams
- BMP C209: Outlet Protection

Installation Schedules: Prior to and during grading

Inspection and Maintenance plan:

- Repair and replace rock as necessary.
- Remove sediment when 30 percent of structure capacity is filled.

Responsible Staff: Contractor

## Element 9: Control Pollutants (2.1.9)

The following pollutants are anticipated to be present on-site:

**Table 2 – Pollutants**

<b>Pollutant (and source, if applicable)</b>
Concrete
Fuel
Paints and supplies
Residential building, insulation, and roofing materials

All pollutants, including waste materials and demolition debris, that occur onsite shall be handled and disposed of in a manner that does not cause contamination of stormwater. Good housekeeping and preventative measures will be taken to ensure that the site will be kept clean, well-organized, and free of debris. If required, BMPs to be implemented to control specific sources of pollutants are discussed below.

### Chemical storage:

- Any chemicals stored in the construction areas will conform to the appropriate source control BMPs listed in Volume IV of the Ecology stormwater manual. In Western WA, all chemicals shall have cover, containment, and protection provided on site, per BMP C153 for Material Delivery, Storage and Containment in SWMMWW 2005
- Application of agricultural chemicals, including fertilizers and pesticides, shall be conducted in a manner and at application rates that will not result in loss of chemical to stormwater runoff. Manufacturers' recommendations for application procedures and rates shall be followed.

### Excavation and tunneling spoils dewatering waste:

- Dewatering BMPs and BMPs specific to the excavation and tunneling (including handling of contaminated soils) are discussed under Element 10.

### Demolition:

- Dust released from demolished sidewalks, buildings, or structures will be controlled using Dust Control measures (BMP C140).
- Storm drain inlets vulnerable to stormwater discharge carrying dust, soil, or debris will be protected using Storm Drain Inlet Protection (BMP C220 as described above for Element 7).
- Process water and slurry resulting from sawcutting and surfacing operations will be prevented from entering the waters of the State by implementing Sawcutting and Surfacing Pollution Prevention measures (BMP C152).

Concrete and grout:

- Process water and slurry resulting from concrete work will be prevented from entering the waters of the State by implementing Concrete Handling measures (BMP C151). Concrete wash out areas shall not be allowed on bare dirt or allowed to drain to bare dirt or the storm system.

Sanitary wastewater:

- Portable sanitation facilities will be firmly secured, regularly maintained, and emptied when necessary.
- Wheel wash or tire bath wastewater shall be discharged to a separate onsite treatment system or to the sanitary sewer as part of Wheel Wash implementation (BMP C106).

Solid Waste:

- Solid waste will be stored in secure, clearly marked containers.

Other:

- Other BMPs will be administered as necessary to address any additional pollutant sources on site.

The facility does not require a Spill Prevention, Control, and Countermeasure (SPCC) Plan under the Federal regulations of the Clean Water Act (CWA).

Installation Schedules: Prior to and during building construction

Inspection and Maintenance plan:

- Return unused concrete remaining in the truck and pump to the originating batch plant for recycling. Do not dump excess concrete on site, except in designated concrete washout areas.
- Wash off hand tools including, but not limited to, screeds, shovels, rakes, floats, and trowels into formed areas only.
- Wash equipment difficult to move, such as concrete pavers in areas that do not directly drain to natural or constructed stormwater conveyances.
- Do not allow washdown from areas, such as concrete aggregate driveways, to drain directly to natural or constructed stormwater conveyances.
- Contain wash water and leftover product in a lined container when no formed areas are available. Dispose of contained concrete in a manner that does not violate ground water or surface water quality standards.

Responsible Staff: Contractor

Will maintenance, fueling, and/or repair of heavy equipment and vehicles occur on-site?

Yes **No**

Will wheel wash or tire bath system BMPs be used during construction?

Yes **No**



Will pH-modifying sources be present on-site? Yes

**Table 3 – pH-Modifying Sources**

	None
	Bulk cement
	Cement kiln dust
	Fly ash
x	Other cementitious materials
x	New concrete washing or curing waters
x	Waste streams generated from concrete grinding and sawing
	Exposed aggregate processes
	Dewatering concrete vaults
x	Concrete pumping and mixer washout waters
	Recycled concrete
	Other (i.e. calcium lignosulfate) [please describe]

List and describe BMPs:

BMP C252: High pH Neutralization Using CO<sub>2</sub>

Installation Schedules: As needed

Inspection and Maintenance plan:

- Weekly

Responsible Staff: Contractor

Concrete trucks must not be washed out onto the ground, or into storm drains, open ditches, streets, or streams. Excess concrete must not be dumped on-site, except in designated concrete washout areas with appropriate BMPs installed.

## Element 10: Control Dewatering (2.1.10)

Dewatering may be required as part of the utility trenching and/or excavation of the stormwater vaults. Dewatering BMPs will include installing a shallow sump in the bottom of the trench of vault excavation with pumping to the onsite sediment control facility. Turbid water will be treated in the pond or tank through quiescent settling and/or discharge to a dispersion system.

Only clean, non-turbid dewatering water (such as well-point groundwater) will be discharged to systems tributary to, or directly into, surface waters of the State, provided the dewatering flow does not cause erosion or flooding of receiving waters.

**Table 4 – Dewatering BMPs**

	Infiltration
	Transport off-site in a vehicle (vacuum truck for legal disposal)
	Ecology-approved on-site chemical treatment or other suitable treatment technologies
x	Sanitary or combined sewer discharge with local sewer district approval (last resort)
x	Use of sedimentation bag with discharge to ditch or swale (small volumes of localized dewatering)

List and describe BMPs:

BMP C206: Level Spreader

Installation Schedules: During construction

Inspection and Maintenance plan:

- The contractor should avoid the placement of any material on the structure and should prevent construction traffic from crossing over the structure.
- If the spreader is damaged by construction traffic, it shall be immediately repaired.

Responsible Staff: Contractor

## **Element 11: Maintain BMPs (2.1.11)**

All temporary and permanent Erosion and Sediment Control (ESC) BMPs shall be maintained and repaired as needed to ensure continued performance of their intended function.

Maintenance and repair shall be conducted in accordance with each particular BMP specification (see *Volume II of the SWMMWW* or *Chapter 7 of the SWMMEW*).

Visual monitoring of all BMPs installed at the site will be conducted at least once every calendar week and within 24 hours of any stormwater or non-stormwater discharge from the site. If the site becomes inactive and is temporarily stabilized, the inspection frequency may be reduced to once every calendar month.

All temporary ESC BMPs shall be removed within 30 days after final site stabilization is achieved or after the temporary BMPs are no longer needed.

Trapped sediment shall be stabilized on-site or removed. Disturbed soil resulting from removal of either BMPs or vegetation shall be permanently stabilized.

Additionally, protection must be provided for all BMPs installed for the permanent control of stormwater from sediment and compaction. BMPs that are to remain in place following completion of construction shall be examined and restored to full operating condition. If sediment enters these BMPs during construction, the sediment shall be removed and the facility shall be returned to conditions specified in the construction documents.

## Element 12: Manage the Project (2.1.12)

The project will be managed based on the following principles:

- Projects will be phased to the maximum extent practicable and seasonal work limitations will be taken into account.
- Inspection and monitoring:
  - Inspection, maintenance and repair of all BMPs will occur as needed to ensure performance of their intended function.
  - Site inspections and monitoring will be conducted in accordance with Special Condition S4 of the CSWGP. Sampling locations are indicated on the [Site Map](#). Sampling station(s) are located in accordance with applicable requirements of the CSWGP.
- Maintain an updated SWPPP.
  - The SWPPP will be updated, maintained, and implemented in accordance with Special Conditions S3, S4, and S9 of the CSWGP.

As site work progresses the SWPPP will be modified routinely to reflect changing site conditions. The SWPPP will be reviewed monthly to ensure the content is current.

**Table 5 – Management**

x	Design the project to fit the existing topography, soils, and drainage patterns
x	Emphasize erosion control rather than sediment control
x	Minimize the extent and duration of the area exposed
x	Keep runoff velocities low
x	Retain sediment on-site
x	Thoroughly monitor site and maintain all ESC measures
x	Schedule major earthwork during the dry season
	Other (please describe)



### **Element 13: Protect Low Impact Development (LID) BMPs (2.1.13)**

No structural infiltration-based flow control BMPs are being proposed for the project. Selected graded slopes will be restored to native meadow by roughening the surface to increase surface storage, amending the soil, and planting native vegetative species.

## Pollution Prevention Team (3.0)

Table 7 – Team Information

<b>Title</b>	<b>Name(s)</b>	<b>Phone Number</b>
<b>Certified Erosion and Sediment Control Lead (CESCL)</b>	TBD	TBD
<b>Resident Engineer</b>	TBD	TBD
<b>Emergency Ecology Contact</b>	Northwest Regional Office	425-640-7000
<b>Emergency Permittee/ Owner Contact</b>	Mike and Elizabeth Huber	TBD
<b>Non-Emergency Owner Contact</b>	Mike and Elizabeth Huber	TBD
<b>City of Mercer Island</b>	Business hours contact	206-275-7730
<b>City of Mercer Island</b>	After hours contact	206-275-7605
<b>Monitoring Personnel</b>	PanGeo	206-262-0370
<b>Ecology Regional Office</b>	Northwest Regional Office	425-640-7000

## Monitoring and Sampling Requirements (4.0)

Monitoring includes visual inspection, sampling for water quality parameters of concern, and documentation of the inspection and sampling findings in a site log book. A site log book will be maintained for all on-site construction activities and will include:

- A record of the implementation of the SWPPP and other permit requirements
- Site inspections
- Stormwater sampling data

The site log book must be maintained on-site within reasonable access to the site and be made available upon request to Ecology or the local jurisdiction.

Numeric effluent limits may be required for certain discharges to 303(d) listed waterbodies. See CSWGP Special Condition S8 and Section 5 of this template.

Complete the following paragraph for sites that discharge to impaired waterbodies for fine sediment, turbidity, phosphorus, or pH:

### Site Inspection (4.1)

Site inspections will be conducted at least once every calendar week and within 24 hours following any discharge from the site. For sites that are temporarily stabilized and inactive, the required frequency is reduced to once per calendar month.

The discharge point(s) are indicated on the Site Map (see Appendix A) and in accordance with the applicable requirements of the CSWGP.

### Stormwater Quality Sampling (4.2)

#### Turbidity Sampling (4.2.1)

Requirements include calibrated turbidity meter or transparency tube to sample site discharges for compliance with the CSWGP. Sampling will be conducted at all discharge points at least once per calendar week.

Method for sampling turbidity:

**Table 8 – Turbidity Sampling Method**

x	Turbidity Meter/Turbidimeter (required for disturbances 5 acres or greater in size)
	Transparency Tube (option for disturbances less than 1 acre and up to 5 acres in size)

The benchmark for turbidity value is 25 nephelometric turbidity units (NTU) and a transparency less than 33 centimeters.

If the discharge's turbidity is 26 to 249 NTU or the transparency is less than 33 cm but equal to or greater than 6 cm, the following steps will be conducted:



1. Review the SWPPP for compliance with Special Condition S9. Make appropriate revisions within 7 days of the date the discharge exceeded the benchmark.
2. Immediately begin the process to fully implement and maintain appropriate source control and/or treatment BMPs as soon as possible. Address the problems within 10 days of the date the discharge exceeded the benchmark. If installation of necessary treatment BMPs is not feasible within 10 days, Ecology may approve additional time when the Permittee requests an extension within the initial 10-day response period.
3. Document BMP implementation and maintenance in the site log book.

If the turbidity exceeds 250 NTU or the transparency is 6 cm or less at any time, the following steps will be conducted:

1. Telephone or submit an electronic report to the applicable Ecology Region's Environmental Report Tracking System (ERTS) within 24 hours.  
<https://www.ecology.wa.gov/About-us/Get-involved/Report-an-environmental-issue>
  - Central Region (Benton, Chelan, Douglas, Kittitas, Klickitat, Okanogan, Yakima): (509) 575-2490
  - Eastern Region (Adams, Asotin, Columbia, Ferry, Franklin, Garfield, Grant, Lincoln, Pend Oreille, Spokane, Stevens, Walla Walla, Whitman): (509) 329-3400
  - Northwest Region (King, Kitsap, Island, San Juan, Skagit, Snohomish, Whatcom): (425) 649-7000
  - Southwest Region (Clallam, Clark, Cowlitz, Grays Harbor, Jefferson, Lewis, Mason, Pacific, Pierce, Skamania, Thurston, Wahkiakum,): (360) 407-6300
2. Immediately begin the process to fully implement and maintain appropriate source control and/or treatment BMPs as soon as possible. Address the problems within 10 days of the date the discharge exceeded the benchmark. If installation of necessary treatment BMPs is not feasible within 10 days, Ecology may approve additional time when the Permittee requests an extension within the initial 10-day response period
3. Document BMP implementation and maintenance in the site log book.
4. Continue to sample discharges daily until one of the following is true:
  - Turbidity is 25 NTU (or lower).
  - Transparency is 33 cm (or greater).
  - Compliance with the water quality limit for turbidity is achieved.
    - 1 - 5 NTU over background turbidity, if background is less than 50 NTU
    - 1% - 10% over background turbidity, if background is 50 NTU or greater
  - The discharge stops or is eliminated.

## **pH Sampling (4.2.2)**

pH monitoring is required for "Significant concrete work" (i.e. greater than 1000 cubic yards poured concrete or recycled concrete over the life of the project). The use of engineered soils

(soil amendments including but not limited to Portland cement-treated base [CTB], cement kiln dust [CKD] or fly ash) also requires pH monitoring.

For significant concrete work, pH sampling will start the first day concrete is poured and continue until it is cured, typically three (3) weeks after the last pour.

For engineered soils and recycled concrete, pH sampling begins when engineered soils or recycled concrete are first exposed to precipitation and continues until the area is fully stabilized.

If the measured pH is 8.5 su or greater, the following measures will be taken:

1. Prevent high pH water from entering storm sewer systems or surface water.
2. Adjust or neutralize the high pH water to the range of 6.5 to 8.5 su using appropriate technology such as carbon dioxide (CO<sub>2</sub>) sparging (liquid or dry ice).
3. Written approval will be obtained from Ecology prior to the use of chemical treatment other than CO<sub>2</sub> sparging or dry ice.

Method for sampling pH:

**Table 8 – pH Sampling Method**

x	pH meter
	pH test kit
	Wide range pH indicator paper

## **Discharges to 303(d) or Total Maximum Daily Load (TMDL) Waterbodies (5.0)**

### **303(d) Listed Waterbodies (5.1)**

Is the receiving water 303(d) (Category 5) listed for turbidity, fine sediment, phosphorus, or pH?

Yes                      No

List the impairment(s): Lake Washington (directly adjacent to our project) is listed by Washington State Department of Ecology as a Category 2 water body for PCBs, and Category 1 water body for Bacteria – Fecal coliform, Phosphorus, and Bacteria – Escherichai coli. See Appendix F

## **Reporting and Record Keeping (6.0)**

### **Record Keeping (6.1)**

#### **Site Log Book (6.1.1)**

A site log book will be maintained for all on-site construction activities and will include:

- A record of the implementation of the SWPPP and other permit requirements
- Site inspections
- Sample logs

#### **Records Retention (6.1.2)**

Records will be retained during the life of the project and for a minimum of three (3) years following the termination of permit coverage in accordance with Special Condition S5.C of the CSWGP.

Permit documentation to be retained on-site:

- CSWGP
- Permit Coverage Letter
- SWPPP
- Site Log Book

Permit documentation will be provided within 14 days of receipt of a written request from Ecology. A copy of the SWPPP or access to the SWPPP will be provided to the public when requested in writing in accordance with Special Condition S5.G.2.b of the CSWGP.

#### **Updating the SWPPP (6.1.3)**

The SWPPP will be modified if:

- Found ineffective in eliminating or significantly minimizing pollutants in stormwater discharges from the site.
- There is a change in design, construction, operation, or maintenance at the construction site that has, or could have, a significant effect on the discharge of pollutants to waters of the State.

The SWPPP will be modified within seven (7) days if inspection(s) or investigation(s) determine additional or modified BMPs are necessary for compliance. An updated timeline for BMP implementation will be prepared.

## **Reporting (6.2)**

### **Discharge Monitoring Reports (6.2.1)**

**Cumulative soil disturbance is less than (1) acre.**

### **Notification of Noncompliance (6.2.2)**

If any of the terms and conditions of the permit is not met, and the resulting noncompliance may cause a threat to human health or the environment, the following actions will be taken:

1. Ecology will be notified within 24-hours of the failure to comply by calling the applicable Regional office ERTS phone number (Regional office numbers listed below).
2. Immediate action will be taken to prevent the discharge/pollution or otherwise stop or correct the noncompliance. If applicable, sampling and analysis of any noncompliance will be repeated immediately and the results submitted to Ecology within five (5) days of becoming aware of the violation.
3. A detailed written report describing the noncompliance will be submitted to Ecology within five (5) days, unless requested earlier by Ecology.

Anytime turbidity sampling indicates turbidity is 250 NTUs or greater, or water transparency is 6 cm or less, the Ecology Regional office will be notified by phone within 24 hours of analysis as required by Special Condition S5.A of the CSWGP.

- Northwest Region at (425) 649-7000 for Island, King, Kitsap, San Juan, Skagit, Snohomish, or Whatcom County

Include the following information:

1. Your name and / Phone number
2. Permit number
3. City / County of project
4. Sample results
5. Date / Time of call
6. Date / Time of sample
7. Project name

In accordance with Special Condition S4.D.5.b of the CSWGP, the Ecology Regional office will be notified if chemical treatment other than CO<sub>2</sub> sparging is planned for adjustment of high pH water.

## **Appendices**

**A. Site Map**

**B. BMP Details**

**C. Correspondence**

**D. Site Inspection Form**

**E. Construction Stormwater General Permit (CSWGP)**

**F. 303(d) List Information**

**G. Engineering Calculations**

## A. Site Map

# FIGURE 1 - VICINITY MAP

SCALE: NTS

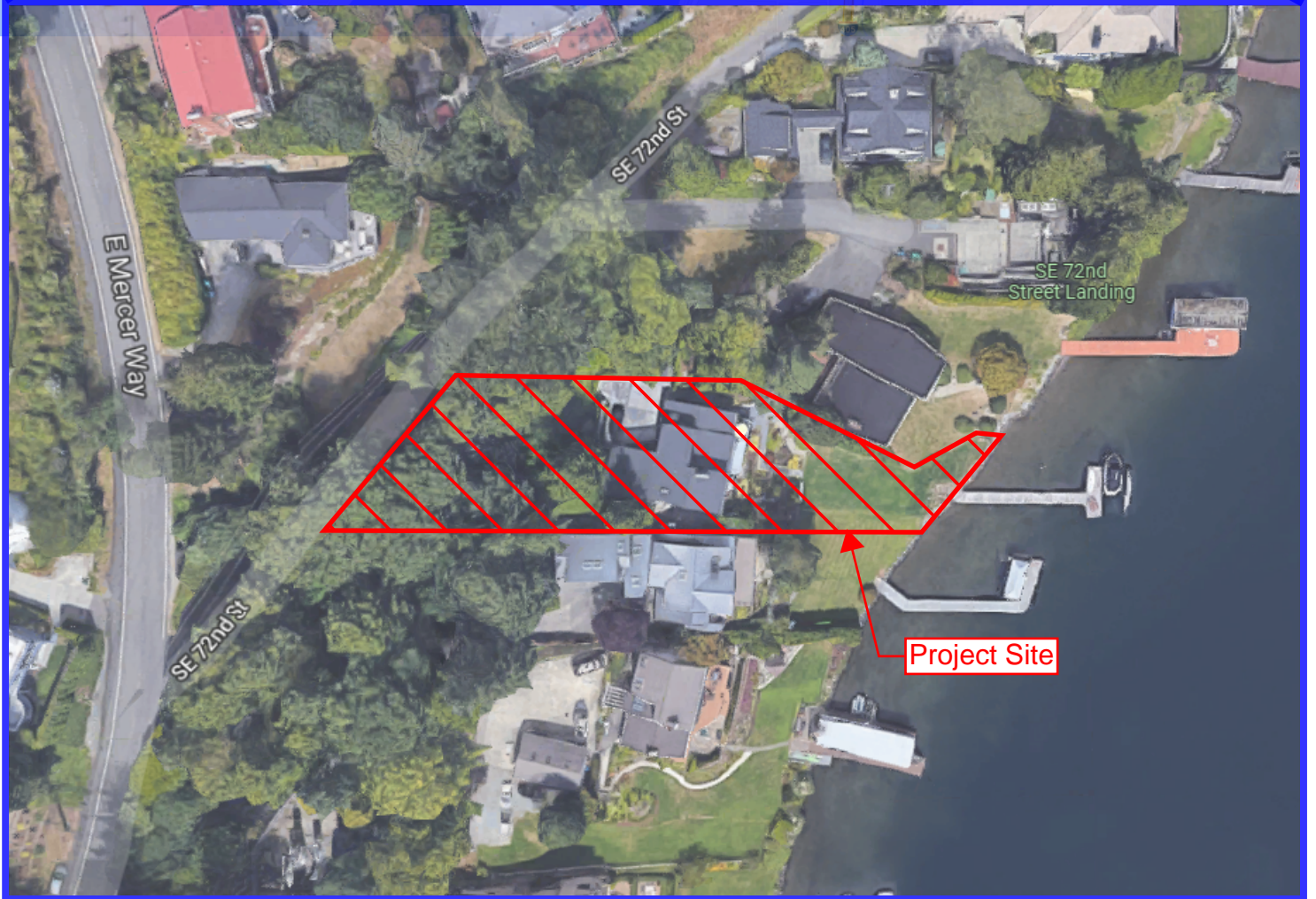
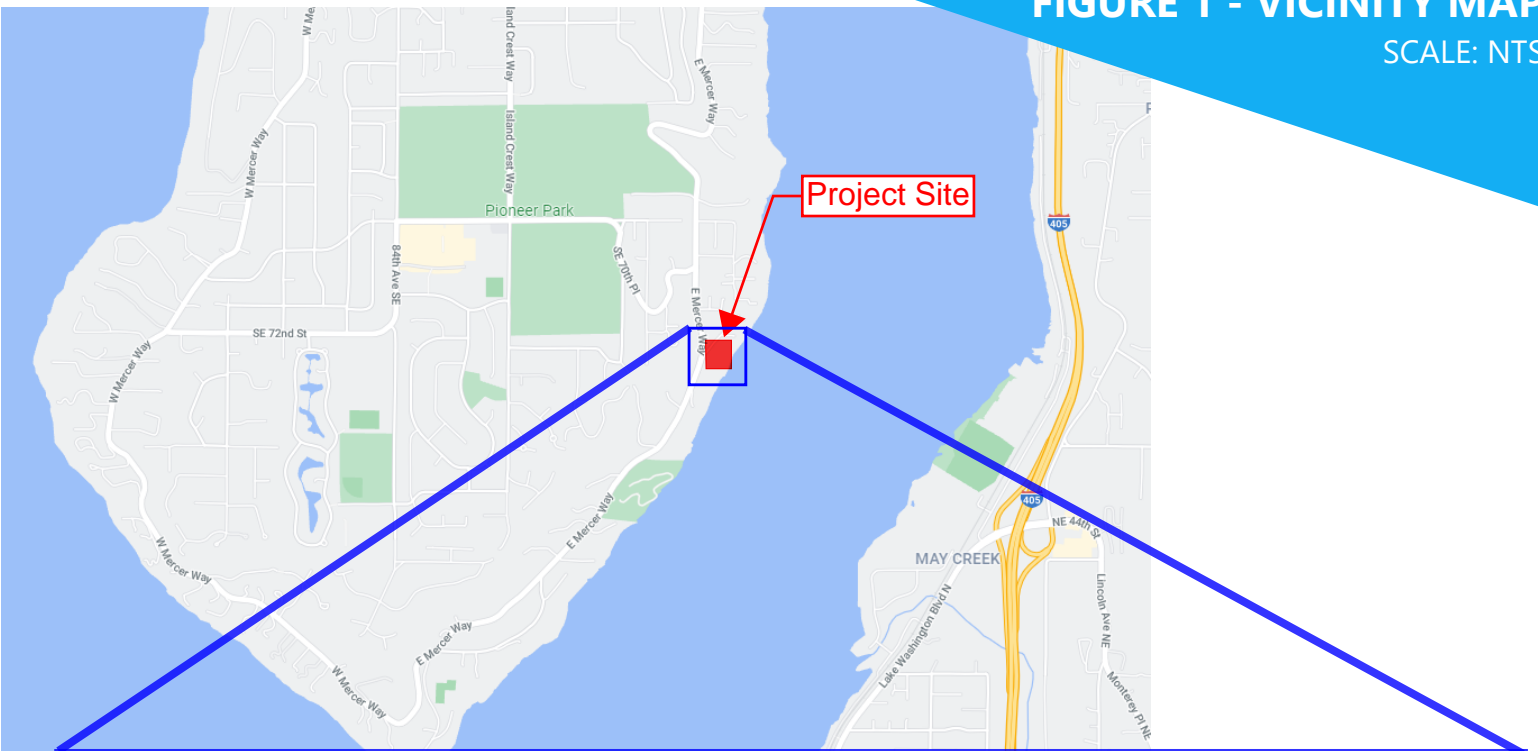

Images from: Google Maps  
09/13/2021



## **B. BMP Details**

# **BMP C101: Preserving Natural Vegetation**

## ***Purpose***

The purpose of preserving natural vegetation is to reduce erosion wherever practicable. Limiting site disturbance is the single most effective method for reducing erosion. For example, conifers can hold up to about 50 percent of all rain that falls during a storm. Up to 20-30 percent of this rain may never reach the ground but is taken up by the tree or evaporates. Another benefit is that the rain held in the tree can be released slowly to the ground after the storm.

## ***Conditions of Use***

Natural vegetation should be preserved on steep slopes, near perennial and intermittent water-courses or swales, and on building sites in wooded areas.

- As required by local governments.
- Phase construction to preserve natural vegetation on the project site for as long as possible during the construction period.

## ***Design and Installation Specifications***

Natural vegetation can be preserved in natural clumps or as individual trees, shrubs and vines.

The preservation of individual plants is more difficult because heavy equipment is generally used to remove unwanted vegetation. The points to remember when attempting to save individual plants are:

- Is the plant worth saving? Consider the location, species, size, age, vigor, and the work involved. Local governments may also have ordinances to save natural vegetation and trees.
- Fence or clearly mark areas around trees that are to be saved. It is preferable to keep ground disturbance away from the trees at least as far out as the dripline.

Plants need protection from three kinds of injuries:

- *Construction Equipment* - This injury can be above or below the ground level. Damage results from scarring, cutting of roots, and compaction of the soil. Placing a fenced buffer zone around plants to be saved prior to construction can prevent construction equipment injuries.
- *Grade Changes* - Changing the natural ground level will alter grades, which affects the plant's ability to obtain the necessary air, water, and minerals. Minor fills usually do not cause problems although sensitivity between species does vary and should be checked. Trees can typically tolerate fill of 6 inches or less. For shrubs and other plants, the fill should be less.

When there are major changes in grade, it may become necessary to supply air to the roots of plants. This can be done by placing a layer of gravel and a tile system over the roots before the fill is made. The tile system should be laid out on the original grade leading from a dry well

around the tree trunk. The system should then be covered with small stones to allow air to circulate over the root area.

Lowering the natural ground level can seriously damage trees and shrubs. The highest percentage of the plant roots are in the upper 12 inches of the soil and cuts of only 2-3 inches can cause serious injury. To protect the roots it may be necessary to terrace the immediate area around the plants to be saved. If roots are exposed, construction of retaining walls may be needed to keep the soil in place. Plants can also be preserved by leaving them on an undisturbed, gently sloping mound. To increase the chances for survival, it is best to limit grade changes and other soil disturbances to areas outside the dripline of the plant.

- *Excavations* - Protect trees and other plants when excavating for drainfields, power, water, and sewer lines. Where possible, the trenches should be routed around trees and large shrubs. When this is not possible, it is best to tunnel under them. This can be done with hand tools or with power augers. If it is not possible to route the trench around plants to be saved, then the following should be observed:
  - Cut as few roots as possible. When you have to cut, cut clean. Paint cut root ends with a wood dressing like asphalt base paint if roots will be exposed for more than 24-hours.
  - Backfill the trench as soon as possible.
  - Tunnel beneath root systems as close to the center of the main trunk to preserve most of the important feeder roots.

Some problems that can be encountered with a few specific trees are:

- Maple, Dogwood, Red alder, Western hemlock, Western red cedar, and Douglas fir do not readily adjust to changes in environment and special care should be taken to protect these trees.
- The windthrow hazard of Pacific silver fir and madrona is high, while that of Western hemlock is moderate. The danger of windthrow increases where dense stands have been thinned. Other species (unless they are on shallow, wet soils less than 20 inches deep) have a low windthrow hazard.
- Cottonwoods, maples, and willows have water-seeking roots. These can cause trouble in sewer lines and infiltration fields. On the other hand, they thrive in high moisture conditions that other trees would not.
- Thinning operations in pure or mixed stands of Grand fir, Pacific silver fir, Noble fir, Sitka spruce, Western red cedar, Western hemlock, Pacific dogwood, and Red alder can cause serious disease problems. Disease can become established through damaged limbs, trunks, roots, and freshly cut stumps. Diseased and weakened trees are also susceptible to insect attack.

## ***Maintenance Standards***

Inspect flagged and/or fenced areas regularly to make sure flagging or fencing has not been removed or damaged. If the flagging or fencing has been damaged or visibility reduced, it shall be repaired or replaced immediately and visibility restored.

If tree roots have been exposed or injured, “prune” cleanly with an appropriate pruning saw or loppers directly above the damaged roots and recover with native soils. Treatment of sap flowing trees (fir, hemlock, pine, soft maples) is not advised as sap forms a natural healing barrier.

## **BMP C103: High-Visibility Fence**

### ***Purpose***

High-visibility fencing is intended to:

- Restrict clearing to approved limits.
- Prevent disturbance of sensitive areas, their buffers, and other areas required to be left undisturbed.
- Limit construction traffic to designated construction entrances, exits, or internal roads.
- Protect areas where marking with survey tape may not provide adequate protection.

### ***Conditions of Use***

To establish clearing limits plastic, fabric, or metal fence may be used:

- At the boundary of sensitive areas, their buffers, and other areas required to be left uncleared.
- As necessary to control vehicle access to and on the site.

### ***Design and Installation Specifications***

High-visibility plastic fence shall be composed of a high-density polyethylene material and shall be at least four feet in height. Posts for the fencing shall be steel or wood and placed every 6 feet on center (maximum) or as needed to ensure rigidity. The fencing shall be fastened to the post every six inches with a polyethylene tie. On long continuous lengths of fencing, a tension wire or rope shall be used as a top stringer to prevent sagging between posts. The fence color shall be high-visibility orange. The fence tensile strength shall be 360 lbs/ft using the ASTM D4595 testing method.

If appropriate install fabric silt fence in accordance with [BMP C233: Silt Fence](#) to act as high-visibility fence. Silt fence shall be at least 3 feet high and must be highly visible to meet the requirements of this BMP.

Metal fences shall be designed and installed according to the manufacturer's specifications.

Metal fences shall be at least 3 feet high and must be highly visible.

Fences shall not be wired or stapled to trees.

## Maintenance Standards

If the fence has been damaged or visibility reduced, it shall be repaired or replaced immediately and visibility restored.

## BMP C105: Stabilized Construction Access

### Purpose

Stabilized construction accesses are established to reduce the amount of sediment transported onto paved roads outside the project site by vehicles or equipment. This is done by constructing a stabilized pad of quarry spalls at entrances and exits for project sites.

### Conditions of Use

Construction accesses shall be stabilized wherever traffic will be entering or leaving a construction site if paved roads or other paved areas are within 1,000 feet of the site.

For residential subdivision construction sites, provide a stabilized construction access for each residence, rather than only at the main subdivision entrance. Stabilized surfaces shall be of sufficient length/width to provide vehicle access/parking, based on lot size and configuration.

On large commercial, highway, and road projects, the designer should include enough extra materials in the contract to allow for additional stabilized accesses not shown in the initial Construction SWPPP. It is difficult to determine exactly where access to these projects will take place; additional materials will enable the contractor to install them where needed.

### Design and Installation Specifications

See [Figure II-3.1: Stabilized Construction Access](#) for details. Note: the 100' minimum length of the access shall be reduced to the maximum practicable size when the size or configuration of the site does not allow the full length (100').

Construct stabilized construction accesses with a 12-inch thick pad of 4-inch to 8-inch quarry spalls, a 4-inch course of asphalt treated base (ATB), or use existing pavement. Do not use crushed concrete, cement, or calcium chloride for construction access stabilization because these products raise pH levels in stormwater and concrete discharge to waters of the State is prohibited.

A separation geotextile shall be placed under the spalls to prevent fine sediment from pumping up into the rock pad. The geotextile shall meet the standards listed in [Table II-3.2: Stabilized Construction Access Geotextile Standards](#).

**Table II-3.2: Stabilized Construction Access Geotextile Standards**

Geotextile Property	Required Value
Grab Tensile Strength (ASTM D4751)	200 psi min.

**Table II-3.2: Stabilized Construction Access  
Geotextile Standards (continued)**

Geotextile Property	Required Value
Grab Tensile Elongation (ASTM D4632)	30% max.
Mullen Burst Strength (ASTM D3786-80a)	400 psi min.
AOS (ASTM D4751)	20-45 (U.S. standard sieve size)

- Consider early installation of the first lift of asphalt in areas that will be paved; this can be used as a stabilized access. Also consider the installation of excess concrete as a stabilized access. During large concrete pours, excess concrete is often available for this purpose.
- Fencing (see [BMP C 103: High-Visibility Fence](#)) shall be installed as necessary to restrict traffic to the construction access.
- Whenever possible, the access shall be constructed on a firm, compacted subgrade. This can substantially increase the effectiveness of the pad and reduce the need for maintenance.
- Construction accesses should avoid crossing existing sidewalks and back of walk drains if at all possible. If a construction access must cross a sidewalk or back of walk drain, the full length of the sidewalk and back of walk drain must be covered and protected from sediment leaving the site.

**Alternative Material Specification**

WSDOT has raised safety concerns about the Quarry Spall rock specified above. WSDOT observes that the 4-inch to 8-inch rock sizes can become trapped between Dually truck tires, and then released off-site at highway speeds. WSDOT has chosen to use a modified specification for the rock while continuously verifying that the Stabilized Construction Access remains effective. To remain effective, the BMP must prevent sediment from migrating off site. To date, there has been no performance testing to verify operation of this new specification. Jurisdictions may use the alternative specification, but must perform increased off-site inspection if they use, or allow others to use, it.

Stabilized Construction Accesses may use material that meets the requirements of WSDOT's *Standard Specifications for Road, Bridge, and Municipal Construction* Section 9-03.9(1) ([WSDOT, 2016](#)) for ballast except for the following special requirements.

The grading and quality requirements are listed in [Table II-3.3: Stabilized Construction Access Alternative Material Requirements](#).

**Table II-3.3: Stabilized  
Construction Access  
Alternative Material  
Requirements**

Sieve Size	Percent Passing
2½"	99-100

**Table II-3.3: Stabilized  
Construction Access  
Alternative Material  
Requirements  
(continued)**

Sieve Size	Percent Passing
2"	65-100
¾"	40-80
No. 4	5 max.
No. 100	0-2
% Fracture	75 min.

- All percentages are by weight.
- The sand equivalent value and dust ratio requirements do not apply.
- The fracture requirement shall be at least one fractured face and will apply the combined aggregate retained on the No. 4 sieve in accordance with FOP for AASHTO T 335.

### ***Maintenance Standards***

Quarry spalls shall be added if the pad is no longer in accordance with the specifications.

- If the access is not preventing sediment from being tracked onto pavement, then alternative measures to keep the streets free of sediment shall be used. This may include replacement/cleaning of the existing quarry spalls, street sweeping, an increase in the dimensions of the access, or the installation of [BMP C106: Wheel Wash](#).
- Any sediment that is tracked onto pavement shall be removed by shoveling or street sweeping. The sediment collected by sweeping shall be removed or stabilized on site. The pavement shall not be cleaned by washing down the street, except when high efficiency sweeping is ineffective and there is a threat to public safety. If it is necessary to wash the streets, the construction of a small sump to contain the wash water shall be considered. The sediment would then be washed into the sump where it can be controlled.
- Perform street sweeping by hand or with a high efficiency sweeper. Do not use a non-high efficiency mechanical sweeper because this creates dust and throws soils into storm systems or conveyance ditches.
- Any quarry spalls that are loosened from the pad, which end up on the roadway shall be removed immediately.
- If vehicles are entering or exiting the site at points other than the construction access(es), [BMP C103: High-Visibility Fence](#) shall be installed to control traffic.



- Upon project completion and site stabilization, all construction accesses intended as permanent access for maintenance shall be permanently stabilized.

**Figure II-3.1: Stabilized Construction Access**

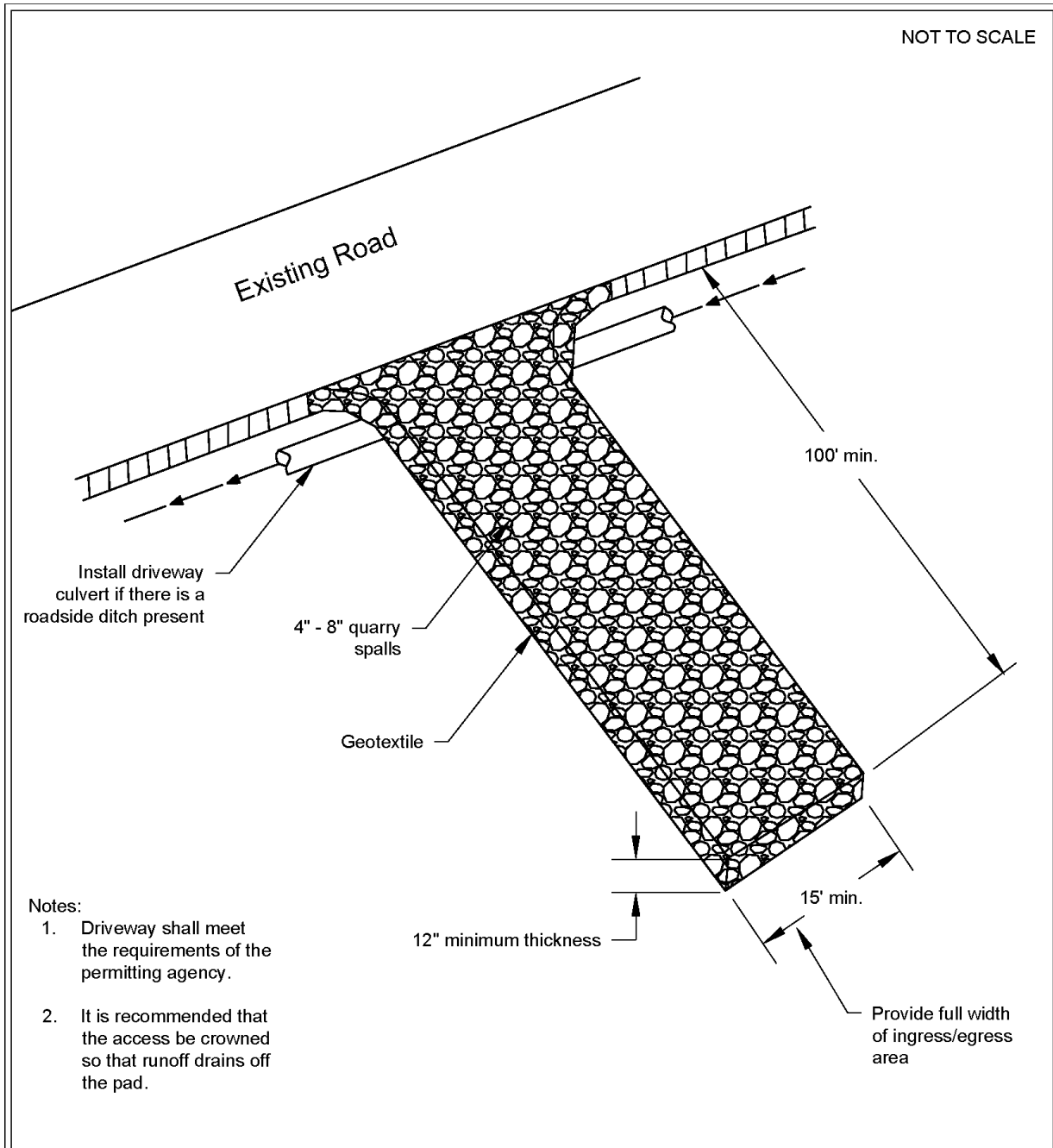

## Stabilized Construction Access

Revised June 2018

Please see <http://www.ecy.wa.gov/copyright.html> for copyright notice including permissions, limitation of liability, and disclaimer.

## ***Approved as Functionally Equivalent***

Ecology has approved products as able to meet the requirements of this BMP. The products did not pass through the Technology Assessment Protocol – Ecology (TAPE) process. Local jurisdictions may choose not to accept these products, or may require additional testing prior to consideration for local use. Products that Ecology has approved as functionally equivalent are available for review on Ecology's website at:

<https://ecology.wa.gov/Regulations-Permits/Guidance-technical-assistance/Stormwater-permittee-guidance-resources/Emerging-stormwater-treatment-technologies>

## **BMP C107: Construction Road / Parking Area Stabilization**

### ***Purpose***

Stabilizing roads, parking areas, and other on-site vehicle transportation routes immediately after grading reduces erosion caused by construction traffic or stormwater runoff.

### ***Conditions of Use***

Roads and parking areas shall be stabilized wherever they are constructed, whether permanent or temporary, for use by construction traffic.

[BMP C103: High-Visibility Fence](#) shall be installed, if necessary, to limit the access of vehicles to only those roads and parking areas that are stabilized.

### ***Design and Installation Specifications***

- On areas that will receive asphalt as part of the project, install the first lift as soon as possible.
- A 6-inch depth of 2- to 4-inch crushed rock, gravel base, or crushed surfacing base course shall be applied immediately after grading or utility installation. A 4-inch course of asphalt treated base (ATB) may also be used, or the road/parking area may be paved. It may also be possible to use cement or calcium chloride for soil stabilization. If cement or cement kiln dust is used for roadbase stabilization, pH monitoring and [BMP C252: Treating and Disposing of High pH Water](#) is necessary to evaluate and minimize the effects on stormwater. If the area will not be used for permanent roads, parking areas, or structures, a 6-inch depth of hog fuel may also be used, but this is likely to require more maintenance. Whenever possible, construction roads and parking areas shall be placed on a firm, compacted subgrade.
- Temporary road gradients shall not exceed 15 percent. Roadways shall be carefully graded to drain. Drainage ditches shall be provided on each side of the roadway in the case of a crowned section, or on one side in the case of a super-elevated section. Drainage ditches shall be directed to a sediment control BMP.
- Rather than relying on ditches, it may also be possible to grade the road so that runoff sheetflows into a heavily vegetated area with a well-developed topsoil. Landscaped areas are not adequate. If this area has at least 50 feet of vegetation that water can flow through, then it is generally preferable to use the vegetation to treat runoff, rather than a sediment pond or trap. The 50 feet shall not include wetlands or their buffers. If runoff is allowed to sheetflow through adjacent vegetated areas, it is vital to design the roadways and parking areas so that no concentrated runoff is created.
- Storm drain inlets shall be protected to prevent sediment-laden water entering the drainage system (see [BMP C220: Inlet Protection](#)).

### ***Maintenance Standards***

Inspect stabilized areas regularly, especially after large storm events.

## **BMP C120: Temporary and Permanent Seeding**

### ***Purpose***

Seeding reduces erosion by stabilizing exposed soils. A well-established vegetative cover is one of the most effective methods of reducing erosion.

### ***Conditions of Use***

Use seeding throughout the project on disturbed areas that have reached final grade or that will remain unworked for more than 30 days.

The optimum seeding windows for western Washington are April 1 through June 30 and September 1 through October 1.

Between July 1 and August 30 seeding requires irrigation until 75 percent grass cover is established.

Between October 1 and March 30 seeding requires a cover of mulch or an erosion control blanket until 75 percent grass cover is established.

Review all disturbed areas in late August to early September and complete all seeding by the end of September. Otherwise, vegetation will not establish itself enough to provide more than average protection.

Mulch is required at all times for seeding because it protects seeds from heat, moisture loss, and transport due to runoff. Mulch can be applied on top of the seed or simultaneously by hydroseeding. See [BMP C121: Mulching](#) for specifications.

Seed and mulch all disturbed areas not otherwise vegetated at final site stabilization. Final stabilization means the completion of all soil disturbing activities at the site and the establishment of a permanent vegetative cover, or equivalent permanent stabilization measures (such as pavement, riprap, gabions, or geotextiles) which will prevent erosion. See [BMP T5.13: Post-Construction Soil Quality and Depth](#).

### ***Design and Installation Specifications***

#### **General**

- Install channels intended for vegetation before starting major earthwork and hydroseed with a Bonded Fiber Matrix. For vegetated channels that will have high flows, install erosion control blankets over the top of hydroseed. Before allowing water to flow in vegetated channels, establish 75 percent vegetation cover. If vegetated channels cannot be established by seed

before water flow; install sod in the channel bottom — over top of hydromulch and erosion control blankets.

- Confirm the installation of all required surface water control measures to prevent seed from washing away.
- Hydroseed applications shall include a minimum of 1,500 pounds per acre of mulch with 3 percent tackifier. See [BMP C121: Mulching](#) for specifications.
- Areas that will have seeding only and not landscaping may need compost or meal-based mulch included in the hydroseed in order to establish vegetation. Re-install native topsoil on the disturbed soil surface before application. See [BMP T5.13: Post-Construction Soil Quality and Depth](#).
- When installing seed via hydroseeding operations, only about 1/3 of the seed actually ends up in contact with the soil surface. This reduces the ability to establish a good stand of grass quickly. To overcome this, consider increasing seed quantities by up to 50 percent.
- Enhance vegetation establishment by dividing the hydromulch operation into two phases:
  - Phase 1- Install all seed and fertilizer with 25-30 percent mulch and tackifier onto soil in the first lift.
  - Phase 2- Install the rest of the mulch and tackifier over the first lift.

Or, enhance vegetation by:

- Installing the mulch, seed, fertilizer, and tackifier in one lift.
- Spread or blow straw over the top of the hydromulch at a rate of 800-1000 pounds per acre.
- Hold straw in place with a standard tackifier.

Both of these approaches will increase cost moderately but will greatly improve and enhance vegetative establishment. The increased cost may be offset by the reduced need for:

- Irrigation.
- Reapplication of mulch.
- Repair of failed slope surfaces.

This technique works with standard hydromulch (1,500 pounds per acre minimum) and Bonded Fiber Matrix/ Mechanically Bonded Fiber Matrix (BFM/MBFMs) (3,000 pounds per acre minimum).

- Seed may be installed by hand if:
  - Temporary and covered by straw, mulch, or topsoil.
  - Permanent in small areas (usually less than 1 acre) and covered with mulch, topsoil, or erosion blankets.
- The seed mixes listed in [Table II-3.4: Temporary and Permanent Seed Mixes](#) include

recommended mixes for both temporary and permanent seeding.

- Apply these mixes, with the exception of the wet area seed mix, at a rate of 120 pounds per acre. This rate can be reduced if soil amendments or slow-release fertilizers are used. Apply the wet area seed mix at a rate of 60 pounds per acre.
- Consult the local suppliers or the local conservation district for their recommendations. The appropriate mix depends on a variety of factors, including location, exposure, soil type, slope, and expected foot traffic. Alternative seed mixes approved by the local authority may be used, depending on the soil type and hydrology of the area.

**Table II-3.4: Temporary and Permanent Seed Mixes**

Common Name	Latin Name	% Weight	% Purity	% Germination
<b>Temporary Erosion Control Seed Mix</b>				
A standard mix for areas requiring a temporary vegetative cover.				
Chewings or annual blue grass	<i>Festuca rubra var. commutata</i> or <i>Poa anna</i>	40	98	90
Perennial rye	<i>Lolium perenne</i>	50	98	90
Redtop or colonial bentgrass	<i>Agrostis alba</i> or <i>Agrostis tenuis</i>	5	92	85
White dutch clover	<i>Trifolium repens</i>	5	98	90
<b>Landscaping Seed Mix</b>				
A recommended mix for landscaping seed.				
Perennial rye blend	<i>Lolium perenne</i>	70	98	90
Chewings and red fescue blend	<i>Festuca rubra var. commutata</i> or <i>Festuca rubra</i>	30	98	90
<b>Low-Growing Turf Seed Mix</b>				
A turf seed mix for dry situations where there is no need for watering. This mix requires very little maintenance.				
Dwarf tall fescue (several varieties)	<i>Festuca arundinacea var.</i>	45	98	90
Dwarf perennial rye (Barclay)	<i>Lolium perenne var. barclay</i>	30	98	90
Red fescue	<i>Festuca rubra</i>	20	98	90
Colonial bentgrass	<i>Agrostis tenuis</i>	5	98	90
<b>Bioswale Seed Mix</b>				
A seed mix for bioswales and other intermittently wet areas.				
Tall or meadow fes-	<i>Festuca arundin-</i>	75-80	98	90

**Table II-3.4: Temporary and Permanent Seed Mixes (continued)**

Common Name	Latin Name	% Weight	% Purity	% Germination
cue	<i>acea</i> or <i>Festuca elatior</i>			
Seaside/Creeping bentgrass	<i>Agrostis palustris</i>	10-15	92	85
Redtop bentgrass	<i>Agrostis alba</i> or <i>Agrostis gigantea</i>	5-10	90	80
<b>Wet Area Seed Mix</b>				
A low-growing, relatively non-invasive seed mix appropriate for very wet areas that are not regulated wetlands. Consult Hydraulic Permit Authority (HPA) for seed mixes if applicable.				
Tall or meadow fescue	<i>Festuca arundinacea</i> or <i>Festuca elatior</i>	60-70	98	90
Seaside/Creeping bentgrass	<i>Agrostis palustris</i>	10-15	98	85
Meadow foxtail	<i>Alepocurus pratensis</i>	10-15	90	80
Alsike clover	<i>Trifolium hybridum</i>	1-6	98	90
Redtop bentgrass	<i>Agrostis alba</i>	1-6	92	85
<b>Meadow Seed Mix</b>				
A recommended meadow seed mix for infrequently maintained areas or non-maintained areas where colonization by native plants is desirable. Likely applications include rural road and utility right-of-way. Seeding should take place in September or very early October in order to obtain adequate establishment prior to the winter months. Consider the appropriateness of clover, a fairly invasive species, in the mix. Amending the soil can reduce the need for clover.				
Redtop or Oregon bentgrass	<i>Agrostis alba</i> or <i>Agrostis oregonensis</i>	20	92	85
Red fescue	<i>Festuca rubra</i>	70	98	90
White dutch clover	<i>Trifolium repens</i>	10	98	90

**Roughening and Rototilling**

- The seedbed should be firm and rough. Roughen all soil no matter what the slope. Track walk slopes before seeding if engineering purposes require compaction. Backblading or smoothing of slopes greater than 4H:1V is not allowed if they are to be seeded.
- Restoration-based landscape practices require deeper incorporation than that provided by a simple single-pass rototilling treatment. Wherever practical, initially rip the subgrade to improve long-term permeability, infiltration, and water inflow qualities. At a minimum,



permanent areas shall use soil amendments to achieve organic matter and permeability performance defined in engineered soil/landscape systems. For systems that are deeper than 8 inches complete the rototilling process in multiple lifts, or prepare the engineered soil system per specifications and place to achieve the specified depth.

### **Fertilizers**

- Conducting soil tests to determine the exact type and quantity of fertilizer is recommended. This will prevent the over-application of fertilizer.
- Organic matter is the most appropriate form of fertilizer because it provides nutrients (including nitrogen, phosphorus, and potassium) in the least water-soluble form.
- In general, use 10-4-6 N-P-K (nitrogen-phosphorus-potassium) fertilizer at a rate of 90 pounds per acre. Always use slow-release fertilizers because they are more efficient and have fewer environmental impacts. Do not add fertilizer to the hydromulch machine, or agitate, more than 20 minutes before use. Too much agitation destroys the slow-release coating.
- There are numerous products available that take the place of chemical fertilizers. These include several with seaweed extracts that are beneficial to soil microbes and organisms. If 100 percent cottonseed meal is used as the mulch in hydroseed, chemical fertilizer may not be necessary. Cottonseed meal provides a good source of long-term, slow-release, available nitrogen.

### **Bonded Fiber Matrix and Mechanically Bonded Fiber Matrix**

- On steep slopes use Bonded Fiber Matrix (BFM) or Mechanically Bonded Fiber Matrix (MBFM) products. Apply BFM/MBFM products at a minimum rate of 3,000 pounds per acre with approximately 10 percent tackifier. Achieve a minimum of 95 percent soil coverage during application. Numerous products are available commercially. Most products require 24-36 hours to cure before rainfall and cannot be installed on wet or saturated soils. Generally, products come in 40-50 pound bags and include all necessary ingredients except for seed and fertilizer.
- Install products per manufacturer's instructions.
- BFMs and MBFMs provide good alternatives to blankets in most areas requiring vegetation establishment. Advantages over blankets include:
  - BFMs and MBFMs do not require surface preparation.
  - Helicopters can assist in installing BFM and MBFMs in remote areas.
  - On slopes steeper than 2.5H:1V, blanket installers may require ropes and harnesses for safety.
  - Installing BFM and MBFMs can save at least \$1,000 per acre compared to blankets.

## ***Maintenance Standards***

Reseed any seeded areas that fail to establish at least 75 percent cover (100 percent cover for areas that receive sheet or concentrated flows). If reseeding is ineffective, use an alternate method such as sodding, mulching, nets, or blankets.

- Reseed and protect by mulch any areas that experience erosion after achieving adequate cover. Reseed and protect by mulch any eroded area.
- Supply seeded areas with adequate moisture, but do not water to the extent that it causes run-off.

## ***Approved as Functionally Equivalent***

Ecology has approved products as able to meet the requirements of this BMP. The products did not pass through the Technology Assessment Protocol – Ecology (TAPE) process. Local jurisdictions may choose not to accept these products, or may require additional testing prior to consideration for local use. Products that Ecology has approved as functionally equivalent are available for review on Ecology’s website at:

<https://ecology.wa.gov/Regulations-Permits/Guidance-technical-assistance/Stormwater-permittee-guidance-resources/Emerging-stormwater-treatment-technologies>

## **BMP C121: Mulching**

### ***Purpose***

Mulching soils provides immediate temporary protection from erosion. Mulch also enhances plant establishment by conserving moisture, holding fertilizer, seed, and topsoil in place, and moderating soil temperatures. There are a variety of mulches that can be used. This section discusses only the most common types of mulch.

### ***Conditions of Use***

As a temporary cover measure, mulch should be used:

- For less than 30 days on disturbed areas that require cover.
- At all times for seeded areas, especially during the wet season and during the hot summer months.
- During the wet season on slopes steeper than 3H:1V with more than 10 feet of vertical relief.

Mulch may be applied at any time of the year and must be refreshed periodically.

For seeded areas, mulch may be made up of 100 percent:

- cottonseed meal;
- fibers made of wood, recycled cellulose, hemp, or kenaf;

- compost;
- or blends of these.

Tackifier shall be plant-based, such as guar or alpha plantago, or chemical-based such as polyacrylamide or polymers.

Generally, mulches come in 40-50 pound bags. Seed and fertilizer are added at time of application.

Recycled cellulose may contain polychlorinated biphenyl (PCBs). Ecology recommends that products should be evaluated for PCBs prior to use.

Refer to [BMP C126: Polyacrylamide \(PAM\) for Soil Erosion Protection](#) for conditions of use. PAM shall not be directly applied to water or allowed to enter a water body.

Any mulch or tackifier product used shall be installed per the manufacturer’s instructions.

## **Design and Installation Specifications**

For mulch materials, application rates, and specifications, see [Table II-3.6: Mulch Standards and Guidelines](#). Consult with the local supplier or the local conservation district for their recommendations. Increase the application rate until the ground is 95% covered (i.e. not visible under the mulch layer). Note: Thickness may be increased for disturbed areas in or near sensitive areas or other areas highly susceptible to erosion.

Where the option of “Compost” is selected, it should be a coarse compost that meets the size gradations listed in [Table II-3.5: Size Gradations of Compost as Mulch Material](#) when tested in accordance with Test Method 02.02-B found in *Test Methods for the Examination of Composting and Compost* (Thompson, 2001).

**Table II-3.5: Size Gradations of Compost as Mulch Material**

Sieve Size	Percent Passing
3"	100%
1"	90% - 100%
3/4"	70% - 100%
1/4"	40% - 100%

Mulch used within the ordinary high-water mark of surface waters should be selected to minimize potential flotation of organic matter. Composted organic materials have higher specific gravities (densities) than straw, wood, or chipped material. Consult the Hydraulic Permit Authority (HPA) for mulch mixes if applicable.

## **Maintenance Standards**

The thickness of the mulch cover must be maintained.

Any areas that experience erosion shall be remulched and/or protected with a net or blanket. If the erosion problem is drainage related, then the problem shall be fixed and the eroded area remulched.

**Table II-3.6: Mulch Standards and Guidelines**

Mulch Material	Guideline	Description
Straw	Quality Standards	Air-dried; free from undesirable seed and coarse material.
	Application Rates	2"-3" thick; 5 bales per 1,000 sf or 2-3 tons per acre
	Remarks	Cost-effective protection when applied with adequate thickness. Hand-application generally requires greater thickness than blown straw. The thickness of straw may be reduced by half when used in conjunction with seeding. In windy areas straw must be held in place by crimping, using a tackifier, or covering with netting. Blown straw always has to be held in place with a tackifier as even light winds will blow it away. Straw, however, has several deficiencies that should be considered when selecting mulch materials. It often introduces and/or encourages the propagation of weed species and it has no significant long-term benefits. It should also not be used within the ordinary high-water elevation of surface waters (due to flotation).
Hydromulch	Quality Standards	No growth inhibiting factors.
	Application Rates	Approx. 35-45 lbs per 1,000 sf or 1,500 - 2,000 lbs per acre
	Remarks	Shall be applied with hydromulcher. Shall not be used without seed and tackifier unless the application rate is at least doubled. Fibers longer than about 3/4 - 1 inch clog hydromulch equipment. Fibers should be kept to less than 3/4 inch.
Compost	Quality Standards	No visible water or dust during handling. Must be produced per <a href="#">WAC 173-350</a> , Solid Waste Handling Standards, but may have up to 35% biosolids.
	Application Rates	2" thick min.; approx. 100 tons per acre (approx. 750 lbs per cubic yard)
	Remarks	More effective control can be obtained by increasing thickness to 3". Excellent mulch for protecting final grades until landscaping because it can be directly seeded or tilled into soil as an amendment. Compost used for mulch has a coarser size gradation than compost used for <a href="#">BMP C125: Topsoiling / Composting</a> or <a href="#">BMP T5.13: Post-Construction Soil Quality and Depth</a> . It is more stable and practical to use in wet areas and during rainy weather conditions. Do not use near wetlands or near phosphorous impaired water bodies.
Chipped Site Vegetation	Quality Standards	Gradations from fines to 6 inches in length for texture, variation, and interlocking properties. Include a mix of various sizes so that the average size is between 2- and 4- inches.
	Application Rates	2" thick min.;

**Table II-3.6: Mulch Standards and Guidelines (continued)**

Mulch Material	Guideline	Description
	<b>Remarks</b>	<p>This is a cost-effective way to dispose of debris from clearing and grubbing, and it eliminates the problems associated with burning. Generally, it should not be used on slopes above approx. 10% because of its tendency to be transported by runoff. It is not recommended within 200 feet of surface waters. If permanent seeding or planting is expected shortly after mulch, the decomposition of the chipped vegetation may tie up nutrients important to grass establishment.</p> <p>Note: thick application of this material over existing grass, herbaceous species, and some groundcovers could smother and kill vegetation.</p>
<b>Wood-Based Mulch</b>	<b>Quality Standards</b>	No visible water or dust during handling. Must be purchased from a supplier with a Solid Waste Handling Permit or one exempt from solid waste regulations.
	<b>Application Rates</b>	2" thick min.; approx. 100 tons per acre (approx. 750 lbs. per cubic yard)
	<b>Remarks</b>	This material is often called "wood straw" or "hog fuel". The use of mulch ultimately improves the organic matter in the soil. Special caution is advised regarding the source and composition of wood-based mulches. Its preparation typically does not provide any weed seed control, so evidence of residual vegetation in its composition or known inclusion of weed plants or seeds should be monitored and prevented (or minimized).
<b>Wood Strand Mulch</b>	<b>Quality Standards</b>	A blend of loose, long, thin wood pieces derived from native conifer or deciduous trees with high length-to-width ratio.
	<b>Application Rates</b>	2" thick min.
	<b>Remarks</b>	Cost-effective protection when applied with adequate thickness. A minimum of 95-percent of the wood strand shall have lengths between 2 and 10-inches, with a width and thickness between 1/16 and 1/2-inches. The mulch shall not contain resin, tannin, or other compounds in quantities that would be detrimental to plant life. Sawdust or wood shavings shall not be used as mulch. [Specification 9-14.4(4) from the <i>Standard Specifications for Road, Bridge, and Municipal Construction</i> ( <a href="#">WSDOT, 2016</a> )

## **BMP C122: Nets and Blankets**

### *Purpose*

Erosion control nets and blankets are intended to prevent erosion and hold seed and mulch in place on steep slopes and in channels so that vegetation can become well established. In addition, some nets and blankets can be used to permanently reinforce turf to protect drainage ways during high flows.

Nets (commonly called matting) are strands of material woven into an open, but high-tensile strength net (for example, coconut fiber matting). Blankets are strands of material that are not tightly woven, but instead form a layer of interlocking fibers, typically held together by a biodegradable or photodegradable netting (for example, excelsior or straw blankets). They generally have lower tensile strength than nets, but cover the ground more completely. Coir (coconut fiber) fabric comes as both nets and blankets.

## **Conditions of Use**

Erosion control netting and blankets shall be made of natural plant fibers unaltered by synthetic materials.

Erosion control nets and blankets should be used:

- To aid permanent vegetated stabilization of slopes 2H:1V or greater and with more than 10 feet of vertical relief.
- For drainage ditches and swales (highly recommended). The application of appropriate netting or blanket to drainage ditches and swales can protect bare soil from channelized runoff while vegetation is established. Nets and blankets also can capture a great deal of sediment due to their open, porous structure. Nets and blankets can be used to permanently stabilize channels and may provide a cost-effective, environmentally preferable alternative to riprap.

Disadvantages of nets and blankets include:

- Surface preparation is required.
- On slopes steeper than 2.5H:1V, net and blanket installers may need to be roped and harnessed for safety.
- They cost at least \$4,000-6,000 per acre installed.

Advantages of nets and blankets include:

- Installation without mobilizing special equipment.
- Installation by anyone with minimal training
- Installation in stages or phases as the project progresses.
- Installers can hand place seed and fertilizer as they progress down the slope.
- Installation in any weather.
- There are numerous types of nets and blankets that can be designed with various parameters in mind. Those parameters include: fiber blend, mesh strength, longevity, biodegradability, cost, and availability.

An alternative to nets and blankets in some limited conditions is [BMP C202: Riprap Channel Lining](#). Ensure that [BMP C202: Riprap Channel Lining](#) is appropriate before using it as a substitute for nets and blankets.

## Design and Installation Specifications

- See [Figure II-3.3: Channel Installation \(Clackamas County et al., 2008\)](#) and [Figure II-3.4: Slope Installation](#) for typical orientation and installation of nets and blankets used in channels and as slope protection. Note: these are typical only; all nets and blankets must be installed per manufacturer's installation instructions.
- Installation is critical to the effectiveness of these products. If good ground contact is not achieved, runoff can concentrate under the product, resulting in significant erosion.
- Installation of nets and blankets on slopes:
  1. Complete final grade and track walk up and down the slope.
  2. Install hydromulch with seed and fertilizer.
  3. Dig a small trench, approximately 12 inches wide by 6 inches deep along the top of the slope.
  4. Install the leading edge of the net/blanket into the small trench and staple approximately every 18 inches. NOTE: Staples are metal, "U"-shaped, and a minimum of 6 inches long. Longer staples are used in sandy soils. Biodegradable stakes are also available.
  5. Roll the net/blanket slowly down the slope as the installer walks backward. NOTE: The net/blanket rests against the installer's legs. Staples are installed as the net/blanket is unrolled. It is critical that the proper staple pattern is used for the net/blanket being installed. The net/blanket is not to be allowed to roll down the slope on its own as this stretches the net/blanket, making it impossible to maintain soil contact. In addition, no one is allowed to walk on the net/blanket after it is in place.
  6. If the net/blanket is not long enough to cover the entire slope length, the trailing edge of the upper net/blanket should overlap the leading edge of the lower net/blanket and be stapled. On steeper slopes, this overlap should be installed in a small trench, stapled, and covered with soil.
- With the variety of products available, it is impossible to cover all the details of appropriate use and installation. Therefore, it is critical that the designer consult the manufacturer's information and that a site visit takes place in order to ensure that the product specified is appropriate. Information is also available in WSDOT's *Standard Specifications for Road, Bridge, and Municipal Construction* Division 8-01 and Division 9-14 ([WSDOT, 2016](#)).
- Use jute matting in conjunction with mulch ([BMP C121: Mulching](#)). Excelsior, woven straw blankets and coir (coconut fiber) blankets may be installed without mulch. There are many other types of erosion control nets and blankets on the market that may be appropriate in certain circumstances.
- In general, most nets (e.g., jute matting) require mulch in order to prevent erosion because they have a fairly open structure. Blankets typically do not require mulch because they usually provide complete protection of the surface.
- Extremely steep, unstable, wet, or rocky slopes are often appropriate candidates for use of synthetic blankets, as are riverbanks, beaches and other high-energy environments. If

synthetic blankets are used, the soil should be hydromulched first.

- 100-percent biodegradable blankets are available for use in sensitive areas. These organic blankets are usually held together with a paper or fiber mesh and stitching which may last up to a year.
- Most netting used with blankets is photodegradable, meaning it breaks down under sunlight (not UV stabilized). However, this process can take months or years even under bright sun. Once vegetation is established, sunlight does not reach the mesh. It is not uncommon to find non-degraded netting still in place several years after installation. This can be a problem if maintenance requires the use of mowers or ditch cleaning equipment. In addition, birds and small animals can become trapped in the netting.

### ***Maintenance Standards***

- Maintain good contact with the ground. Erosion must not occur beneath the net or blanket.
- Repair and staple any areas of the net or blanket that are damaged or not in close contact with the ground.
- Fix and protect eroded areas if erosion occurs due to poorly controlled drainage.



**Figure II-3.3: Channel Installation**

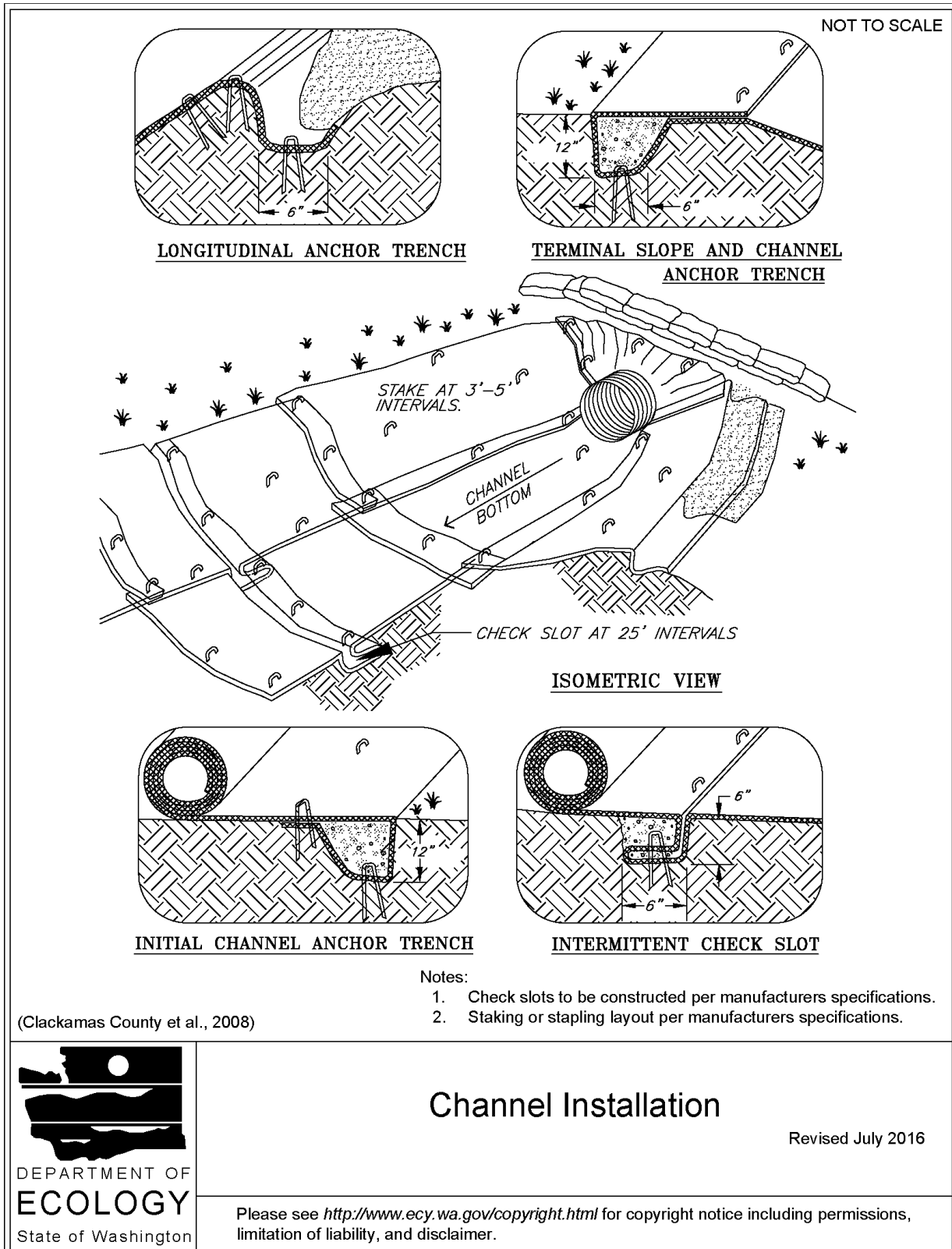

**Figure II-3.4: Slope Installation**

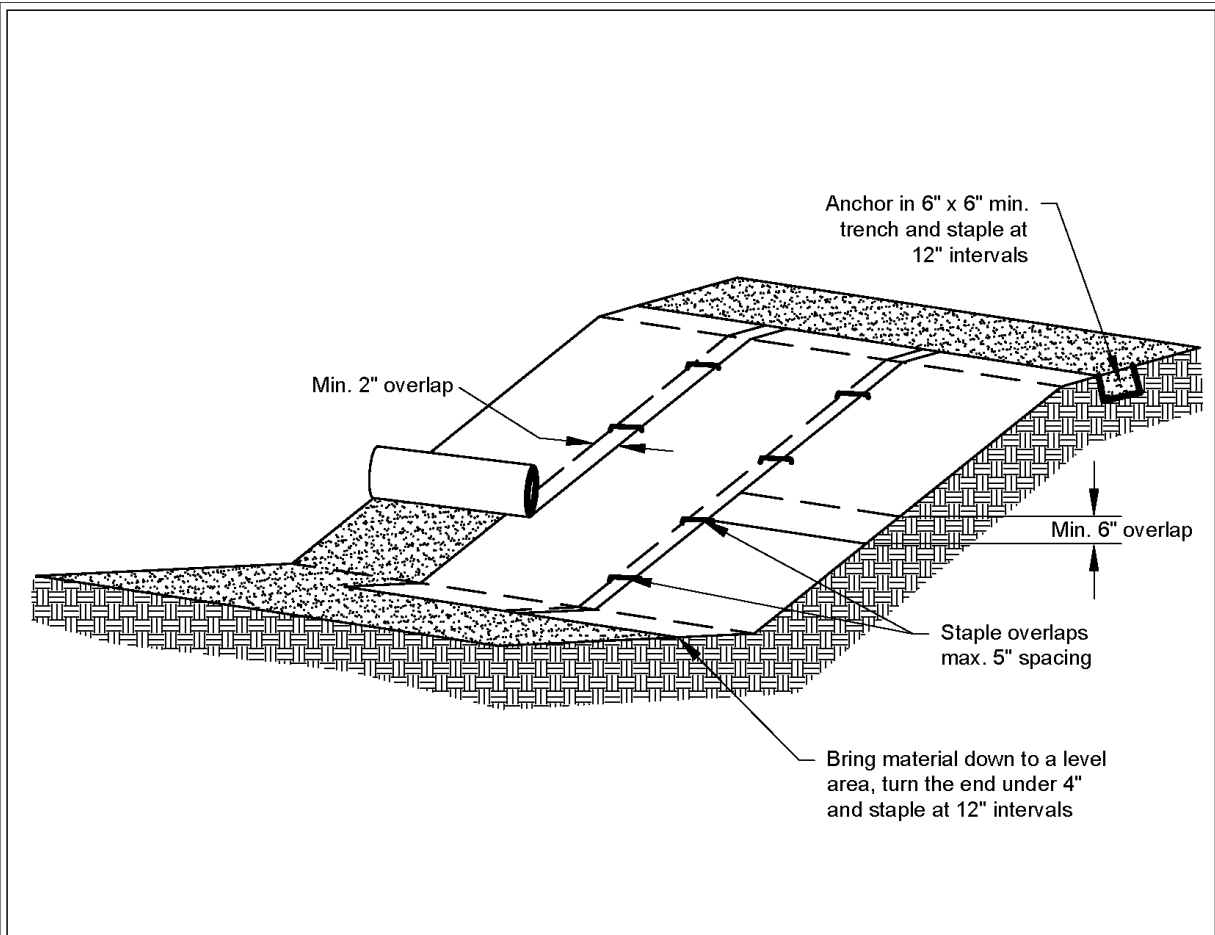

Notes:

1. Slope surface shall be smooth before placement for proper soil contact.
2. Stapling pattern as per manufacturer's recommendations.
3. Do not stretch blankets/matting tight - allow the rolls to mold to any irregularities.
4. For slopes less than 3H:1V, rolls may be placed in horizontal strips.
5. If there is a berm at the top of the slope, anchor upslope of the berm.
6. Lime, fertilize, and seed before installation. Planting of shrubs, trees, etc. should occur after installation.

NOT TO SCALE



## Slope Installation

Revised June 2016

Please see <http://www.ecy.wa.gov/copyright.html> for copyright notice including permissions, limitation of liability, and disclaimer.

## **BMP C123: Plastic Covering**

### ***Purpose***

Plastic covering provides immediate, short-term erosion protection to slopes and disturbed areas.

### ***Conditions of Use***

Plastic covering may be used on disturbed areas that require cover measures for less than 30 days, except as stated below.

- Plastic is particularly useful for protecting cut and fill slopes and stockpiles. However, the relatively rapid breakdown of most polyethylene sheeting makes it unsuitable for applications greater than six months.
- Due to rapid runoff caused by plastic covering, do not use this method upslope of areas that might be adversely impacted by concentrated runoff. Such areas include steep and/or unstable slopes.
- Plastic sheeting may result in increased runoff volumes and velocities, requiring additional on-site measures to counteract the increases. Creating a trough with wattles or other material can convey clean water away from these areas.
- To prevent undercutting, trench and backfill rolled plastic covering products.
- Although the plastic material is inexpensive to purchase, the cost of installation, maintenance, removal, and disposal add to the total costs of this BMP.
- Whenever plastic is used to protect slopes, install water collection measures at the base of the slope. These measures include plastic-covered berms, channels, and pipes used to convey clean rainwater away from bare soil and disturbed areas. Do not mix clean runoff from a plastic covered slope with dirty runoff from a project.
- Other uses for plastic include:
  - Temporary ditch liner.
  - Pond liner in temporary sediment pond.
  - Liner for bermed temporary fuel storage area if plastic is not reactive to the type of fuel being stored.
  - Emergency slope protection during heavy rains.
  - Temporary drainpipe (“elephant trunk”) used to direct water.

### ***Design and Installation Specifications***

- Plastic slope cover must be installed as follows:
  1. Run plastic up and down the slope, not across the slope.
  2. Plastic may be installed perpendicular to a slope if the slope length is less than 10 feet.

3. Provide a minimum of 8-inch overlap at the seams.
  4. On long or wide slopes, or slopes subject to wind, tape all seams.
  5. Place plastic into a small (12-inch wide by 6-inch deep) slot trench at the top of the slope and backfill with soil to keep water from flowing underneath.
  6. Place sand filled burlap or geotextile bags every 3 to 6 feet along seams and tie them together with twine to hold them in place.
  7. Inspect plastic for rips, tears, and open seams regularly and repair immediately. This prevents high velocity runoff from contacting bare soil, which causes extreme erosion.
  8. Sandbags may be lowered into place tied to ropes. However, all sandbags must be staked in place.
- Plastic sheeting shall have a minimum thickness of 0.06 millimeters.
  - If erosion at the toe of a slope is likely, a gravel berm, riprap, or other suitable protection shall be installed at the toe of the slope in order to reduce the velocity of runoff.

### ***Maintenance Standards***

- Torn sheets must be replaced and open seams repaired.
- Completely remove and replace the plastic if it begins to deteriorate due to ultraviolet radiation.
- Completely remove plastic when no longer needed.
- Dispose of old tires used to weight down plastic sheeting appropriately.

### ***Approved as Functionally Equivalent***

Ecology has approved products as able to meet the requirements of this BMP. The products did not pass through the Technology Assessment Protocol – Ecology (TAPE) process. Local jurisdictions may choose not to accept these products, or may require additional testing prior to consideration for local use. Products that Ecology has approved as functionally equivalent are available for review on Ecology's website at:

<https://ecology.wa.gov/Regulations-Permits/Guidance-technical-assistance/Stormwater-permittee-guidance-resources/Emerging-stormwater-treatment-technologies>

## **BMP C130: Surface Roughening**

### ***Purpose***

Surface roughening aids in the establishment of vegetative cover, reduces runoff velocity, increases infiltration, and provides for sediment trapping through the provision of a rough soil surface. Horizontal depressions are created by operating a tiller or other suitable equipment on the contour or by leaving slopes in a roughened condition by not fine grading them.

Use this BMP in conjunction with other BMPs such as [BMP C120: Temporary and Permanent Seeding](#), [BMP C121: Mulching](#), or [BMP C124: Sodding](#).

### ***Conditions for Use***

- All slopes steeper than 3H:1V and greater than 5 vertical feet require surface roughening to a depth of 2 to 4 inches prior to seeding.
- Areas that will not be stabilized immediately may be roughened to reduce runoff velocity until seeding takes place.

- Slopes with a stable rock face do not require roughening.
- Slopes where mowing is planned should not be excessively roughened.

## ***Design and Installation Specifications***

There are different methods for achieving a roughened soil surface on a slope, and the selection of an appropriate method depends upon the type of slope. Roughening methods include stair-step grading, grooving, contour furrows, and tracking. See [Figure II-3.5: Surface Roughening by Tracking and Contour Furrows](#). Factors to be considered in choosing a roughening method are slope steepness, mowing requirements, and whether the slope is formed by cutting or filling.

- Disturbed areas that will not require mowing may be stair-step graded, grooved, or left rough after filling.
- Stair-step grading is particularly appropriate in soils containing large amounts of soft rock. Each "step" catches material that sloughs from above, and provides a level site where vegetation can become established. Stairs should be wide enough to work with standard earth moving equipment. Stair steps must be on contour or gullies will form on the slope.
- Areas that will be mowed (these areas should have slopes less steep than 3H:1V) may have small furrows left by disking, harrowing, raking, or seed-planting machinery operated on the contour.
- Graded areas with slopes steeper than 3H:1V but less than 2H:1V should be roughened before seeding. This can be accomplished in a variety of ways, including "track walking," or driving a crawler tractor up and down the slope, leaving a pattern of cleat imprints parallel to slope contours.
- Tracking is done by operating equipment up and down the slope to leave horizontal depressions in the soil.

## ***Maintenance Standards***

- Areas that are surface roughened should be seeded as quickly as possible.
- Regular inspections should be made of the area. If rills appear, they should be re-roughened and re-seeded immediately.

**Figure II-3.6: Gradient Terraces**

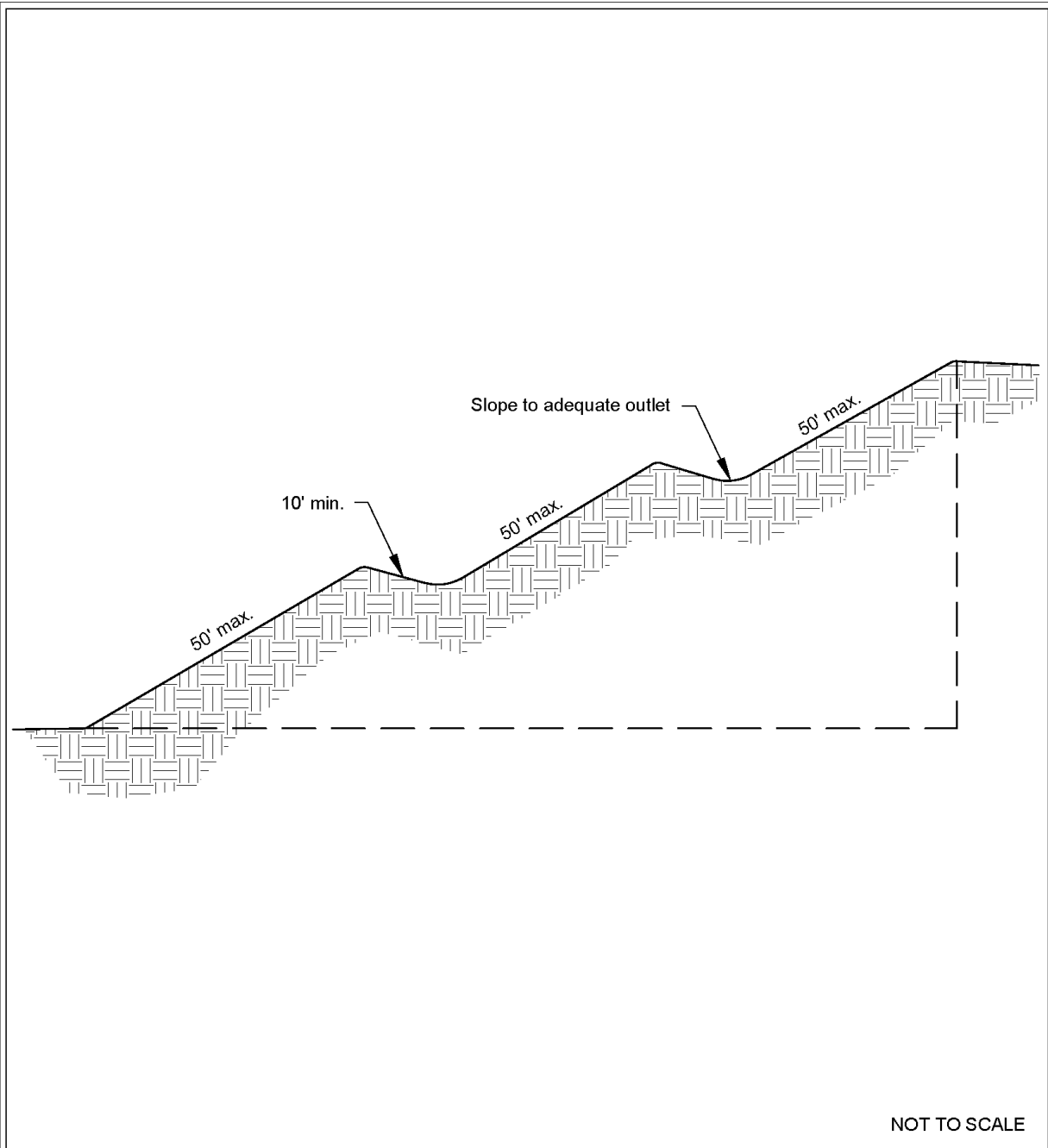

## Gradient Terraces

Revised June 2016

Please see <http://www.ecy.wa.gov/copyright.html> for copyright notice including permissions, limitation of liability, and disclaimer.

## **BMP C140: Dust Control**

### ***Purpose***

Dust control prevents wind transport of dust from disturbed soil surfaces onto roadways, drainage ways, and surface waters.

### ***Conditions of Use***

Use dust control in areas (including roadways) subject to surface and air movement of dust where on-site or off-site impacts to roadways, drainage ways, or surface waters are likely.

### ***Design and Installation Specifications***

- Vegetate or mulch areas that will not receive vehicle traffic. In areas where planting, mulching, or paving is impractical, apply gravel or landscaping rock.
- Limit dust generation by clearing only those areas where immediate activity will take place, leaving the remaining area(s) in the original condition. Maintain the original ground cover as long as practical.
- Construct natural or artificial windbreaks or windscreens. These may be designed as enclosures for small dust sources.
- Sprinkle the site with water until the surface is wet. Repeat as needed. To prevent carryout of mud onto the street, refer to [BMP C 105: Stabilized Construction Access](#) and [BMP C 106: Wheel Wash](#).
- Irrigation water can be used for dust control. Irrigation systems should be installed as a first step on sites where dust control is a concern.
- Spray exposed soil areas with a dust palliative, following the manufacturer's instructions and cautions regarding handling and application. Used oil is prohibited from use as a dust suppressant. Local governments may approve other dust palliatives such as calcium chloride or PAM.
- PAM ([BMP C 126: Polyacrylamide \(PAM\) for Soil Erosion Protection](#)) added to water at a rate of 0.5 pounds per 1,000 gallons of water per acre and applied from a water truck is more effective than water alone. This is due to increased infiltration of water into the soil and reduced evaporation. In addition, small soil particles are bonded together and are not as easily transported by wind. Adding PAM may reduce the quantity of water needed for dust control. Note that the application rate specified here applies to this BMP, and is not the same application rate that is specified in [BMP C 126: Polyacrylamide \(PAM\) for Soil Erosion Protection](#), but the downstream protections still apply.

Refer to [BMP C 126: Polyacrylamide \(PAM\) for Soil Erosion Protection](#) for conditions of use. PAM shall not be directly applied to water or allowed to enter a water body.

- Contact your local Air Pollution Control Authority for guidance and training on other dust control measures. Compliance with the local Air Pollution Control Authority constitutes



compliance with this BMP.

- Use vacuum street sweepers.
- Remove mud and other dirt promptly so it does not dry and then turn into dust.
- Techniques that can be used for unpaved roads and lots include:
  - Lower speed limits. High vehicle speed increases the amount of dust stirred up from unpaved roads and lots.
  - Upgrade the road surface strength by improving particle size, shape, and mineral types that make up the surface and base materials.
  - Add surface gravel to reduce the source of dust emission. Limit the amount of fine particles (those smaller than .075 mm) to 10 to 20 percent.
  - Use geotextile fabrics to increase the strength of new roads or roads undergoing reconstruction.
  - Encourage the use of alternate, paved routes, if available.
  - Apply chemical dust suppressants using the admix method, blending the product with the top few inches of surface material. Suppressants may also be applied as surface treatments.
  - Limit dust-causing work on windy days.
  - Pave unpaved permanent roads and other trafficked areas.

### ***Maintenance Standards***

Respray area as necessary to keep dust to a minimum.

## **BMP C151: Concrete Handling**

### ***Purpose***

Concrete work can generate process water and slurry that contain fine particles and high pH, both of which can violate water quality standards in the receiving water. Concrete spillage or concrete discharge to waters of the State is prohibited. Use this BMP to minimize and eliminate concrete, concrete process water, and concrete slurry from entering waters of the State.

## Conditions of Use

Any time concrete is used, utilize these management practices. Concrete construction project components include, but are not limited to:

- Curbs
- Sidewalks
- Roads
- Bridges
- Foundations
- Floors
- Runways

Disposal options for concrete, in order of preference are:

1. Off-site disposal
2. Concrete wash-out areas (see [BMP C154: Concrete Washout Area](#))
3. De minimus washout to formed areas awaiting concrete

## Design and Installation Specifications

- Wash concrete truck drums at an approved off-site location or in designated concrete washout areas only. Do not wash out concrete trucks onto the ground (including formed areas awaiting concrete), or into storm drains, open ditches, streets, or streams. Refer to [BMP C154: Concrete Washout Area](#) for information on concrete washout areas.
  - Return unused concrete remaining in the truck and pump to the originating batch plant for recycling. Do not dump excess concrete on site, except in designated concrete washout areas as allowed in [BMP C154: Concrete Washout Area](#).
- Wash small concrete handling equipment (e.g. hand tools, screeds, shovels, rakes, floats, trowels, and wheelbarrows) into designated concrete washout areas or into formed areas awaiting concrete pour.
- At no time shall concrete be washed off into the footprint of an area where an infiltration feature will be installed.
- Wash equipment difficult to move, such as concrete paving machines, in areas that do not directly drain to natural or constructed stormwater conveyance or potential infiltration areas.
- Do not allow washwater from areas, such as concrete aggregate driveways, to drain directly (without detention or treatment) to natural or constructed stormwater conveyances.
- Contain washwater and leftover product in a lined container when no designated concrete washout areas (or formed areas, allowed as described above) are available. Dispose of contained concrete and concrete washwater (process water) properly.

- Always use forms or solid barriers for concrete pours, such as pilings, within 15-feet of surface waters.
- Refer to [BMP C252: Treating and Disposing of High pH Water](#) for pH adjustment requirements.
- Refer to the Construction Stormwater General Permit (CSWGP) for pH monitoring requirements if the project involves one of the following activities:
  - Significant concrete work (as defined in the CSWGP).
  - The use of soils amended with (but not limited to) Portland cement-treated base, cement kiln dust or fly ash.
  - Discharging stormwater to segments of water bodies on the 303(d) list (Category 5) for high pH.

### ***Maintenance Standards***

Check containers for holes in the liner daily during concrete pours and repair the same day.

## **BMP C152: Sawcutting and Surfacing Pollution Prevention**

### ***Purpose***

Sawcutting and surfacing operations generate slurry and process water that contains fine particles and high pH (concrete cutting), both of which can violate the water quality standards in the receiving water. Concrete spillage or concrete discharge to waters of the State is prohibited. Use this BMP to minimize and eliminate process water and slurry created through sawcutting or surfacing from entering waters of the State.

### ***Conditions of Use***

Utilize these management practices anytime sawcutting or surfacing operations take place. Sawcutting and surfacing operations include, but are not limited to:

- Sawing
- Coring
- Grinding
- Roughening
- Hydro-demolition
- Bridge and road surfacing

## ***Design and Installation Specifications***

- Vacuum slurry and cuttings during cutting and surfacing operations.
- Slurry and cuttings shall not remain on permanent concrete or asphalt pavement overnight.
- Slurry and cuttings shall not drain to any natural or constructed drainage conveyance including stormwater systems. This may require temporarily blocking catch basins.
- Dispose of collected slurry and cuttings in a manner that does not violate ground water or surface water quality standards.
- Do not allow process water generated during hydro-demolition, surface roughening or similar operations to drain to any natural or constructed drainage conveyance including stormwater systems. Dispose of process water in a manner that does not violate ground water or surface water quality standards.
- Handle and dispose of cleaning waste material and demolition debris in a manner that does not cause contamination of water. Dispose of sweeping material from a pick-up sweeper at an appropriate disposal site.

## ***Maintenance Standards***

Continually monitor operations to determine whether slurry, cuttings, or process water could enter waters of the state. If inspections show that a violation of water quality standards could occur, stop operations and immediately implement preventive measures such as berms, barriers, secondary containment, and/or vacuum trucks.

## **BMP C153: Material Delivery, Storage, and Containment**

### ***Purpose***

Prevent, reduce, or eliminate the discharge of pollutants to the stormwater system or watercourses from material delivery and storage. Minimize the storage of hazardous materials on-site, store materials in a designated area, and install secondary containment.

### ***Conditions of Use***

Use at construction sites with delivery and storage of the following materials:

- Petroleum products such as fuel, oil and grease
- Soil stabilizers and binders (e.g., Polyacrylamide)
- Fertilizers, pesticides and herbicides
- Detergents
- Asphalt and concrete compounds

- Hazardous chemicals such as acids, lime, adhesives, paints, solvents, and curing compounds
- Any other material that may be detrimental if released to the environment

## ***Design and Installation Specifications***

- The temporary storage area should be located away from vehicular traffic, near the construction entrance(s), and away from waterways or storm drains.
- Safety Data Sheets (SDS) should be supplied for all materials stored. Chemicals should be kept in their original labeled containers.
- Hazardous material storage on-site should be minimized.
- Hazardous materials should be handled as infrequently as possible.
- During the wet weather season (Oct 1 – April 30), consider storing materials in a covered area.
- Materials should be stored in secondary containments, such as an earthen dike, horse trough, or even a children’s wading pool for non-reactive materials such as detergents, oil, grease, and paints. Small amounts of material may be secondarily contained in “bus boy” trays or concrete mixing trays.
- Do not store chemicals, drums, or bagged materials directly on the ground. Place these items on a pallet and, when possible, within secondary containment.
- If drums must be kept uncovered, store them at a slight angle to reduce ponding of rainwater on the lids to reduce corrosion. Domed plastic covers are inexpensive and snap to the top of drums, preventing water from collecting.
- Liquids, petroleum products, and substances listed in 40 CFR Parts 110, 117, or 302 shall be stored in approved containers and drums and shall not be overfilled. Containers and drums shall be stored in temporary secondary containment facilities.
- Temporary secondary containment facilities shall provide for a spill containment volume able to contain 10% of the total enclosed container volume of all containers, or 110% of the capacity of the largest container within its boundary, whichever is greater.
- Secondary containment facilities shall be impervious to the materials stored therein for a minimum contact time of 72 hours.
- Sufficient separation should be provided between stored containers to allow for spill cleanup and emergency response access.
- During the wet weather season (Oct 1 – April 30), each secondary containment facility shall be covered during non-working days, prior to and during rain events.
- Keep material storage areas clean, organized and equipped with an ample supply of appropriate spill clean-up material (spill kit).
- The spill kit should include, at a minimum:

- 1-Water Resistant Nylon Bag
- 3-Oil Absorbent Socks 3"x 4'
- 2-Oil Absorbent Socks 3"x 10'
- 12-Oil Absorbent Pads 17"x19"
- 1-Pair Splash Resistant Goggles
- 3-Pair Nitrile Gloves
- 10-Disposable Bags with Ties
- Instructions

### ***Maintenance Standards***

- Secondary containment facilities shall be maintained free of accumulated rainwater and spills. In the event of spills or leaks, accumulated rainwater and spills shall be collected and placed into drums. These liquids shall be handled as hazardous waste unless testing determines them to be non-hazardous.
- Re-stock spill kit materials as needed.

# **BMP C160: Certified Erosion and Sediment Control Lead**

## ***Purpose***

The project proponent designates at least one person as the responsible representative in charge of erosion and sediment control (ESC), and water quality protection. The designated person shall be responsible for ensuring compliance with all local, state, and federal erosion and sediment control and water quality requirements. Construction sites one acre or larger that discharge to waters of the State must designate a Certified Erosion and Sediment Control Lead (CESCL) as the responsible representative.

## ***Conditions of Use***

A CESCL shall be made available on projects one acre or larger that discharge stormwater to surface waters of the state. Sites less than one acre may have a person without CESCL certification conduct inspections.

The CESCL shall:

- Have a current certificate proving attendance in an erosion and sediment control training course that meets the minimum ESC training and certification requirements established by Ecology.

Ecology has provided the minimum requirements for CESCL course training, as well as a list of ESC training and certification providers at:

<https://ecology.wa.gov/Regulations-Permits/Permits-certifications/Certified-erosion-sediment-control>

**OR**

- Be a Certified Professional in Erosion and Sediment Control (CPESC). For additional information go to:

<http://www.envirocertintl.org/cpesc/>

## ***Specifications***

- CESCL certification shall remain valid for three years.
- The CESCL shall have authority to act on behalf of the contractor or project proponent and shall be available, or on-call, 24 hours per day throughout the period of construction.
- The Construction SWPPP shall include the name, telephone number, fax number, and address of the designated CESCL. See [II-2 Construction Stormwater Pollution Prevention Plans \(Construction SWPPPs\)](#).
- A CESCL may provide inspection and compliance services for multiple construction projects in the same geographic region, but must be on site whenever earthwork activities are



occurring that could generate release of turbid water.

- Duties and responsibilities of the CESCL shall include, but are not limited to the following:
  - Maintaining a permit file on site at all times which includes the Construction SWPPP and any associated permits and plans.
  - Directing BMP installation, inspection, maintenance, modification, and removal.
  - Updating all project drawings and the Construction SWPPP with changes made.
  - Completing any sampling requirements including reporting results using electronic Discharge Monitoring Reports (WebDMR).
  - Facilitate, participate in, and take corrective actions resulting from inspections performed by outside agencies or the owner.
  - Keeping daily logs, and inspection reports. Inspection reports should include:
    - Inspection date/time.
    - Weather information; general conditions during inspection and approximate amount of precipitation since the last inspection.
    - Visual monitoring results, including a description of discharged stormwater. The presence of suspended sediment, turbid water, discoloration, and oil sheen shall be noted, as applicable.
    - Any water quality monitoring performed during inspection.
    - General comments and notes, including a brief description of any BMP repairs, maintenance or installations made as a result of the inspection.
    - A summary or list of all BMPs implemented, including observations of all erosion/sediment control structures or practices. The following shall be noted:
      1. Locations of BMPs inspected.
      2. Locations of BMPs that need maintenance.
      3. Locations of BMPs that failed to operate as designed or intended.
      4. Locations of where additional or different BMPs are required.

## **II-3.3 Construction Runoff BMPs**

### **BMP C200: Interceptor Dike and Swale**

#### ***Purpose***

Provide a dike of compacted soil or a swale at the top or base of a disturbed slope or along the perimeter of a disturbed construction area to convey stormwater. Use the dike and/or swale to intercept the runoff from unprotected areas and direct it to areas where erosion can be controlled. This can prevent storm runoff from entering the work area or sediment-laden runoff from leaving the construction site.

#### ***Conditions of Use***

Use an interceptor dike or swale where runoff from an exposed site or disturbed slope must be conveyed to an erosion control BMP which can safely convey the stormwater.

- Locate upslope of a construction site to prevent runoff from entering the disturbed area.
- When placed horizontally across a disturbed slope, it reduces the amount and velocity of runoff flowing down the slope.
- Locate downslope to collect runoff from a disturbed area and direct it to a sediment BMP (e.g. [BMP C240: Sediment Trap](#) or [BMP C241: Sediment Pond \(Temporary\)](#)).

## ***Design and Installation Specifications***

- Dike and/or swale and channel must be stabilized with temporary or permanent vegetation or other channel protection during construction.
  - Steep grades require channel protection and check dams.
  - Review construction for areas where overtopping may occur.
  - Can be used at the top of new fill before vegetation is established.
  - May be used as a permanent diversion channel to carry the runoff.
  - Contributing area for an individual dike or swale should be one acre or less.
  - Design the dike and/or swale to contain flows calculated by one of the following methods:
    - Single Event Hydrograph Method: The peak volumetric flow rate calculated using a 10-minute time step from a Type 1A, 10-year, 24-hour frequency storm for the worst-case land cover condition.
- OR
- Continuous Simulation Method: The 10-year peak flow rate, as determined by an approved continuous runoff model with a 15-minute time step for the worst-case land cover condition.

Worst-case land cover conditions (i.e., producing the most runoff) should be used for analysis (in most cases, this would be the land cover conditions just prior to final landscaping).

### **Interceptor Dikes**

Interceptor dikes shall meet the following criteria:

- Top Width: 2 feet minimum.
- Height: 1.5 feet minimum on berm.
- Side Slope: 2H:1V or flatter.
- Grade: Depends on topography, however, dike system minimum is 0.5%, and maximum is 1%.
- Compaction: Minimum of 90 percent ASTM D698 standard proctor.
- Stabilization: Depends on velocity and reach. Inspect regularly to ensure stability.
- Ground Slopes <5%: Seed and mulch applied within 5 days of dike construction (see [BMP C121: Mulching](#)).
- Ground Slopes 5 - 40%: Dependent on runoff velocities and dike materials. Stabilization should be done immediately using either sod or riprap, or other measures to avoid erosion.
- The upslope side of the dike shall provide positive drainage to the dike outlet. No erosion shall

occur at the outlet. Provide energy dissipation measures as necessary. Sediment-laden runoff must be released through a sediment trapping facility.

- Minimize construction traffic over temporary dikes. Use temporary cross culverts for channel crossing.
- See [Table II-3.8: Horizontal Spacing of Interceptor Dikes Along Ground Slope](#) for recommended horizontal spacing between dikes.

**Table II-3.8: Horizontal Spacing of Interceptor Dikes Along Ground Slope**

Average Slope	Slope Percent	Flowpath Length
20H:1V or less	3-5%	300 feet
(10 to 20)H:1V	5-10%	200 feet
(4 to 10)H:1V	10-25%	100 feet
(2 to 4)H:1V	25-50%	50 feet

### **Interceptor Swales**

Interceptor swales shall meet the following criteria:

- Bottom Width: 2 feet minimum; the cross-section bottom shall be level.
- Depth: 1-foot minimum.
- Side Slope: 2H:1V or flatter.
- Grade: Maximum 5 percent, with positive drainage to a suitable outlet (such as [BMP C241: Sediment Pond \(Temporary\)](#)).
- Stabilization: Seed as per [BMP C120: Temporary and Permanent Seeding](#), or [BMP C202: Riprap Channel Lining](#), 12 inches thick riprap pressed into the bank and extending at least 8 inches vertical from the bottom.

### ***Maintenance Standards***

- Inspect diversion dikes and interceptor swales once a week and after every rainfall. Immediately remove sediment from the flow area.
- Damage caused by construction traffic or other activity must be repaired before the end of each working day.
- Check outlets and make timely repairs as needed to avoid gully formation. When the area below the temporary diversion dike is permanently stabilized, remove the dike and fill and stabilize the channel to blend with the natural surface.

## **BMP C202: Riprap Channel Lining**

### ***Purpose***

To protect channels by providing a channel liner using riprap.

### ***Conditions of Use***

Use this BMP when natural soils or vegetated stabilized soils in a channel are not adequate to prevent channel erosion.

Use this BMP when a permanent ditch or pipe system is to be installed and a temporary measure is needed.

An alternative to riprap channel lining is [BMP C122: Nets and Blankets](#).

The Federal Highway Administration recommends not using geotextile liners whenever the slope exceeds 10 percent or the shear stress exceeds 8 lbs/ft<sup>2</sup>.

### ***Design and Installation Specifications***

- Since riprap is typically used where erosion potential is high, construction must be sequenced so that the riprap is put in place with the minimum possible delay.
- Disturb areas awaiting riprap only when final preparation and placement of the riprap can follow immediately behind the initial disturbance. Where riprap is used for outlet protection, the riprap should be placed before or in conjunction with the construction of the pipe or channel so that it is in place when the pipe or channel begins to operate.
- The designer, after determining the riprap size that will be stable under the flow conditions, shall consider that size to be a minimum size and then, based on riprap gradations actually available in the area, select the size or sizes that equal or exceed the minimum size. The possibility of drainage structure damage by others shall be considered in selecting a riprap size, especially if there is nearby water or a gully in which to toss the stones.
- Stone for riprap shall consist of field stone or quarry stone of approximately rectangular shape. The stone shall be hard and angular and of such quality that it will not disintegrate on exposure to water or weathering and it shall be suitable in all respects for the purpose intended. See Section 9-13 of WSDOT's *Standard Specifications for Road, Bridge, and Municipal Construction* ([WSDOT, 2016](#)).
- A lining of engineering filter fabric (geotextile) shall be placed between the riprap and the underlying soil surface to prevent soil movement into or through the riprap. The geotextile should be keyed in at the top of the bank.
- Filter fabric shall not be used on slopes greater than 1.5H:1V as slippage may occur. It should be used in conjunction with a layer of coarse aggregate (granular filter blanket) when the riprap to be placed is 12 inches and larger.

## ***Maintenance Standards***

Replace riprap as needed.

## **BMP C206: Level Spreader**

### ***Purpose***

The purpose of a level spreader as a Construction Stormwater BMP is to provide a temporary outlet for dikes and diversions and convert concentrated runoff to sheet flow prior to releasing it to stabilized areas.

### ***Conditions of Use***

Use level spreaders when a concentrated flow of water needs to be dispersed over a large area with existing stable vegetation.

Use only where the slopes are gentle, the water volume is relatively low, and the soil will adsorb most of the low flow events.

Items to consider are:

- What is the risk of erosion or damage if the flow becomes concentrated?
- Is an easement required if discharged to adjoining property?

### ***Design and Installation Specifications***

- Use above undisturbed areas that are stabilized by existing vegetation.
- Discharge area below the outlet must be uniform with a slope flatter than 5H:1V.
- Do not allow any low points in the level spreader. If the level spreader has any low points, flow will concentrate, create channels and may cause erosion.
- Ensure the outlet is level in a stable, undisturbed soil profile (not on fill).

- The runoff shall not re-concentrate on site after release from the level spreader unless it is intercepted by another downstream measure.
- The grade of the channel for the last 20 feet of the dike or interceptor entering the level spreader shall be less than or equal to 1 percent. The grade of the level spreader shall be 0 percent to ensure uniform spreading of runoff.
- A 6-inch high gravel berm placed across the level lip shall consist of washed crushed rock, 2- to 4-inch or 3/4-inch to 1½-inch size.
- The spreader length shall be determined by calculating the peak volumetric flow rate using a 10-minute time step from a Type 1A, 10-year, 24-hour design storm. The length of the spreader shall be a minimum of 15 feet for 0.1 cfs and shall increase by 10 feet for each 0.1 cfs thereafter to a maximum of 0.5 cfs per spreader. Use multiple spreaders for higher flows.
- The width of the approach to the spreader should be at least 6 feet.
- The depth of the spreader as measured from the lip should be at least 6 inches and it should be uniform across the entire length.
- Level spreaders shall be set back from the property line unless there is an easement for flow.
- Materials that can be used for level spreaders include sand bags, lumber, logs, concrete, pipe, and capped perforated pipe. To function properly, the material needs to be installed level and on contour.
- See [Figure II-3.14: Cross Section of Level Spreader](#) and [Figure II-3.15: Detail of Level Spreader](#).

### ***Maintenance Standards***

The level spreader should be inspected during and after runoff events to ensure that it is functioning correctly.

- The contractor should avoid the placement of any material on the level spreader, and should prevent construction traffic from crossing over the level spreader.
- If the level spreader is damaged by construction traffic, it shall be immediately repaired.



**Figure II-3.14: Cross Section of Level Spreader**

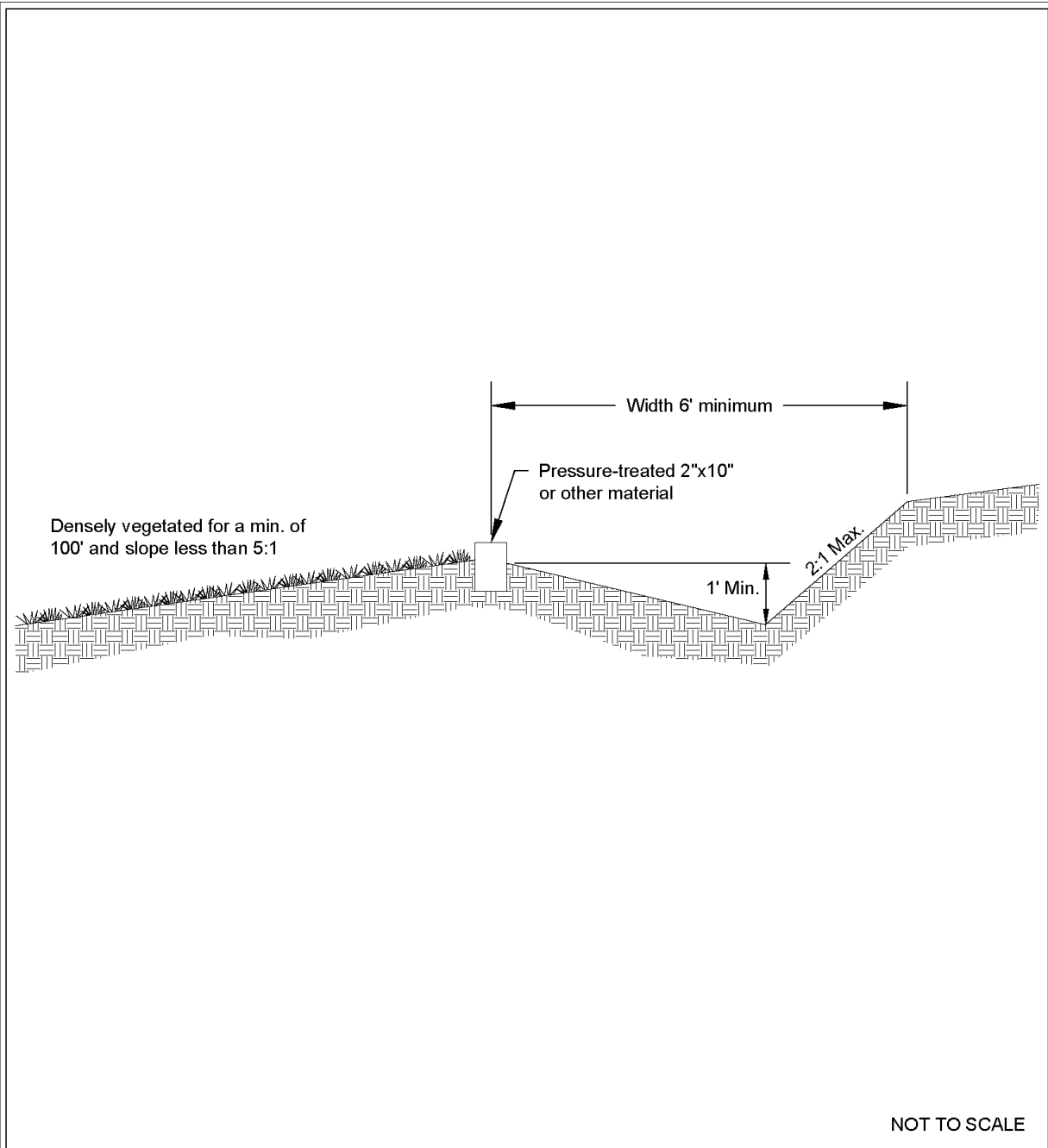

NOT TO SCALE



## Cross Section of Level Spreader

Revised July 2017

Please see <http://www.ecy.wa.gov/copyright.html> for copyright notice including permissions, limitation of liability, and disclaimer.

**Figure II-3.15: Detail of Level Spreader**

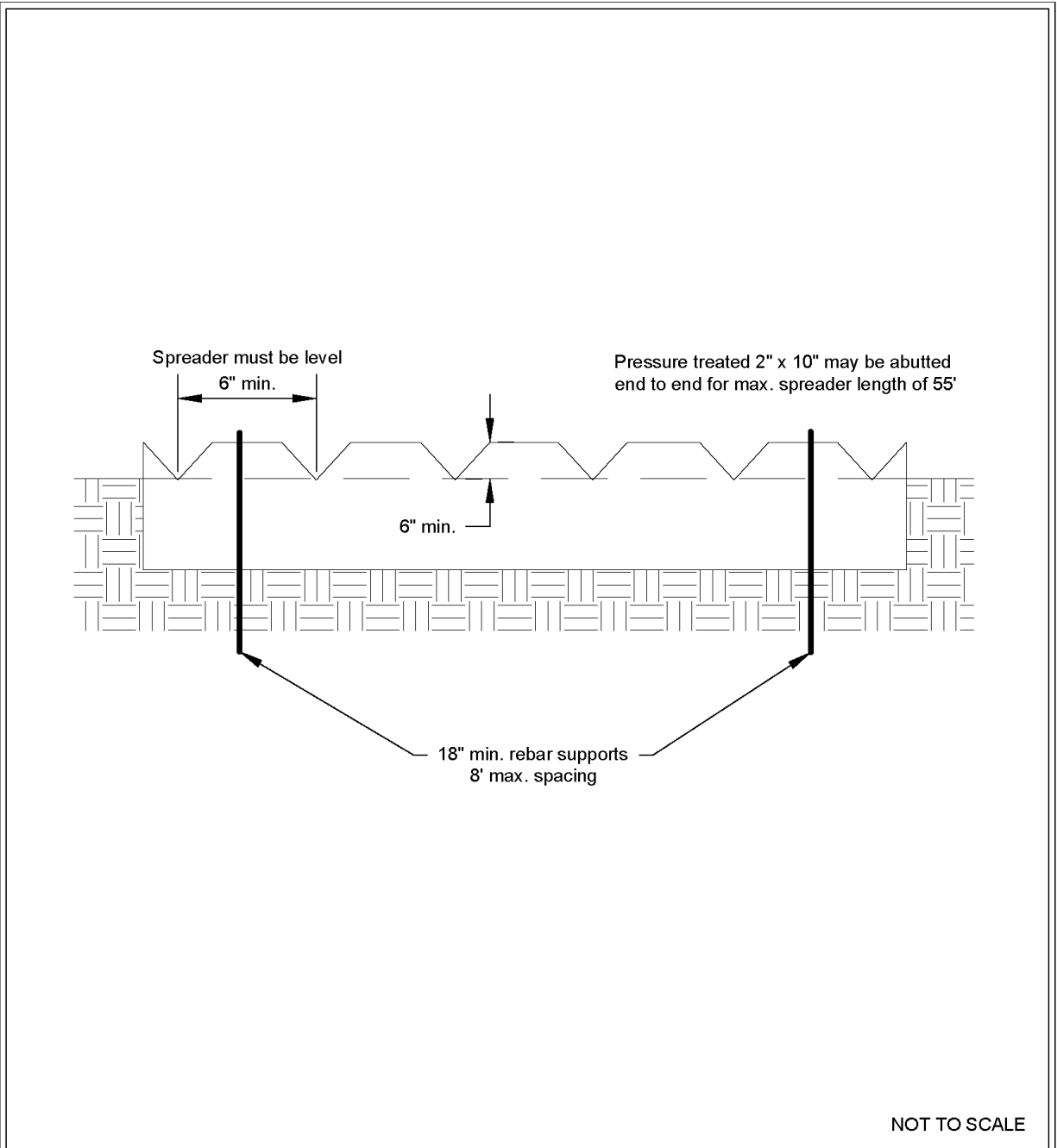

## Detail of Level Spreader

Revised July 2017

Please see <http://www.ecy.wa.gov/copyright.html> for copyright notice including permissions, limitation of liability, and disclaimer.

## **BMP C207: Check Dams**

### ***Purpose***

Construction of check dams across a swale or ditch reduces the velocity of concentrated flow and dissipates energy at the check dam.

### ***Conditions of Use***

Use check dams where temporary or permanent channels are not yet vegetated, channel lining is infeasible, and/or velocity checks are required.

- Check dams may not be placed in streams unless approved by the State Department of Fish and Wildlife.
- Check dams may not be placed in wetlands without approval from a permitting agency.
- Do not place check dams below the expected backwater from any salmonid bearing water between October 1 and May 31 to ensure that there is no loss of high flow refuge habitat for overwintering juvenile salmonids and emergent salmonid fry.

### ***Design and Installation Specifications***

- Construct rock check dams from appropriately sized rock. The rock used must be large enough to stay in place given the expected design flow through the channel. The rock must be placed by hand or by mechanical means (do not dump the rock to form the dam) to achieve complete coverage of the ditch or swale and to ensure that the center of the dam is lower than the edges.
- Check dams may also be constructed of either rock or pea-gravel filled bags. Numerous new products are also available for this purpose. They tend to be re-usable, quick and easy to install, effective, and cost efficient.
- Place check dams perpendicular to the flow of water.
- The check dam should form a triangle when viewed from the side. This prevents undercutting as water flows over the face of the check dam rather than falling directly onto the ditch bottom.
- Before installing check dams, impound and bypass upstream water flow away from the work area. Options for bypassing include pumps, siphons, or temporary channels.
- Check dams combined with sumps work more effectively at slowing flow and retaining sediment than a check dam alone. A deep sump should be provided immediately upstream of the check dam.
- In some cases, if carefully located and designed, check dams can remain as permanent installations with very minor regrading. They may be left as either spillways, in which case accumulated sediment would be graded and seeded, or as check dams to prevent further sediment from leaving the site.
- The maximum spacing between check dams shall be such that the downstream toe of the

upstream dam is at the same elevation as the top of the downstream dam.

- Keep the maximum height at 2 feet at the center of the check dam.
- Keep the center of the check dam at least 12 inches lower than the outer edges at natural ground elevation.
- Keep the side slopes of the check dam at 2H:1V or flatter.
- Key the stone into the ditch banks and extend it beyond the abutments a minimum of 18 inches to avoid washouts from overflow around the dam.
- Use filter fabric foundation under a rock or sand bag check dam. If a blanket ditch liner is used, filter fabric is not necessary. A piece of organic or synthetic blanket cut to fit will also work for this purpose.
- In the case of grass-lined ditches and swales, all check dams and accumulated sediment shall be removed when the grass has matured sufficiently to protect the ditch or swale - unless the slope of the swale is greater than 4 percent. The area beneath the check dams shall be seeded and mulched immediately after dam removal.
- Ensure that channel appurtenances, such as culvert entrances below check dams, are not subject to damage or blockage from displaced stones.
- See [Figure II-3.16: Rock Check Dam](#).

### ***Maintenance Standards***

Check dams shall be monitored for performance and sediment accumulation during and after each rainfall that produces runoff. Sediment shall be removed when it reaches one half the sump depth.

- Anticipate submergence and deposition above the check dam and erosion from high flows around the edges of the dam.
- If significant erosion occurs between dams, install a protective riprap liner in that portion of the channel. See [BMP C202: Riprap Channel Lining](#).

### ***Approved as Functionally Equivalent***

Ecology has approved products as able to meet the requirements of this BMP. The products did not pass through the Technology Assessment Protocol – Ecology (TAPE) process. Local jurisdictions may choose not to accept these products, or may require additional testing prior to consideration for local use. Products that Ecology has approved as functionally equivalent are available for review on Ecology's website at:

<https://ecology.wa.gov/Regulations-Permits/Guidance-technical-assistance/Stormwater-permittee-guidance-resources/Emerging-stormwater-treatment-technologies>

**Figure II-3.16: Rock Check Dam**

View Looking Upstream

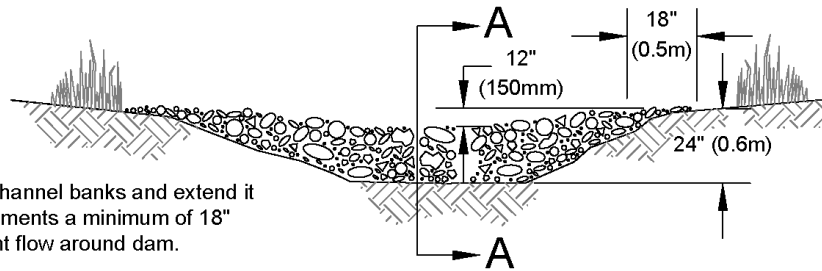

Note:  
Key stone into channel banks and extend it beyond the abutments a minimum of 18" (0.5m) to prevent flow around dam.

Section A-A

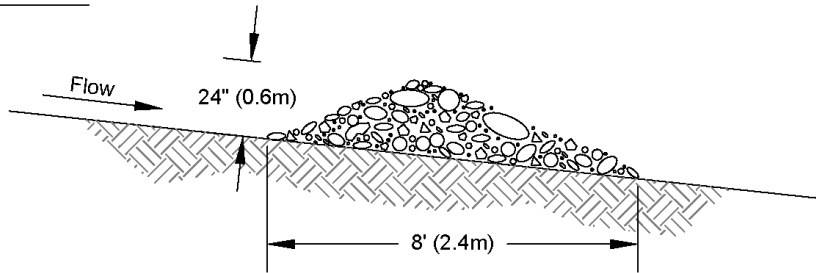

Spacing Between Check Dams

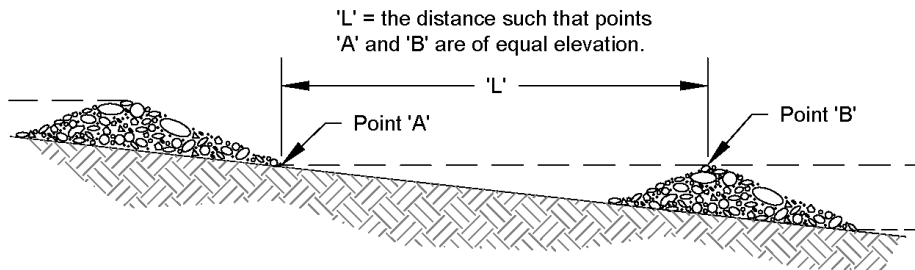

NOT TO SCALE



**Rock Check Dam**

Revised June 2016

Please see <http://www.ecy.wa.gov/copyright.html> for copyright notice including permissions, limitation of liability, and disclaimer.

## **BMP C209: Outlet Protection**

### ***Purpose***

Outlet protection prevents scour at conveyance outlets and minimizes the potential for downstream erosion by reducing the velocity of concentrated stormwater flows.

### ***Conditions of Use***

Use outlet protection at the outlets of all ponds, pipes, ditches, or other conveyances that discharge to a natural or manmade drainage feature such as a stream, wetland, lake, or ditch.

### ***Design and Installation Specifications***

- The receiving channel at the outlet of a pipe shall be protected from erosion by lining a minimum of 6 feet downstream and extending up the channel sides a minimum of 1-foot above the maximum tailwater elevation, or 1-foot above the crown, whichever is higher. For pipes larger than 18 inches in diameter, the outlet protection lining of the channel shall be four times the diameter of the outlet pipe.
- Standard wingwalls, tapered outlets, and paved channels should also be considered when appropriate for permanent culvert outlet protection ([WSDOT, 2015](#)).
- [BMP C122: Nets and Blankets](#) or [BMP C202: Riprap Channel Lining](#) provide suitable options for lining materials.
- With low flows, [BMP C201: Grass-Lined Channels](#) can be an effective alternative for lining material.
- The following guidelines shall be used for outlet protection with riprap:
  - If the discharge velocity at the outlet is less than 5 fps, use 2-inch to 8-inch riprap. Minimum thickness is 1-foot.
  - For 5 to 10 fps discharge velocity at the outlet, use 24-inch to 48-inch riprap. Minimum

thickness is 2 feet.

- For outlets at the base of steep slope pipes (pipe slope greater than 10 percent), use an engineered energy dissipator.
- Filter fabric or erosion control blankets should always be used under riprap to prevent scour and channel erosion. See [BMP C122: Nets and Blankets](#).
- Bank stabilization, bioengineering, and habitat features may be required for disturbed areas. This work may require a Hydraulic Project Approval (HPA) from the Washington State Department of Fish and Wildlife. See [I-2.11 Hydraulic Project Approvals](#).

## **Maintenance Standards**

- Inspect and repair as needed.
- Add rock as needed to maintain the intended function.
- Clean energy dissipator if sediment builds up.

## **BMP C220: Inlet Protection**

### ***Purpose***

Inlet protection prevents coarse sediment from entering drainage systems prior to permanent stabilization of the disturbed area.

### ***Conditions of Use***

Use inlet protection at inlets that are operational before permanent stabilization of the disturbed areas that contribute runoff to the inlet. Provide protection for all storm drain inlets downslope and within 500 feet of a disturbed or construction area, unless those inlets are preceded by a sediment trapping BMP.

Also consider inlet protection for lawn and yard drains on new home construction. These small and numerous drains coupled with lack of gutters can add significant amounts of sediment into the roof drain system. If possible, delay installing lawn and yard drains until just before landscaping, or cap these drains to prevent sediment from entering the system until completion of landscaping. Provide 18-inches of sod around each finished lawn and yard drain.

[Table II-3.10: Storm Drain Inlet Protection](#) lists several options for inlet protection. All of the methods for inlet protection tend to plug and require a high frequency of maintenance. Limit contributing drainage areas for an individual inlet to one acre or less. If possible, provide emergency overflows with additional end-of-pipe treatment where stormwater ponding would cause a hazard.

**Table II-3.10: Storm Drain Inlet Protection**

Type of Inlet Protection	Emergency Overflow	Applicable for Paved/ Earthen Surfaces	Conditions of Use
<b>Drop Inlet Protection</b>			
Excavated drop inlet protection	Yes, temporary flooding may occur	Earthen	Applicable for heavy flows. Easy to maintain. Large area requirement: 30'x30'/acre
Block and gravel drop inlet protection	Yes	Paved or Earthen	Applicable for heavy concentrated flows. Will not pond.
Gravel and wire drop inlet protection	No	Paved or Earthen	Applicable for heavy concentrated flows. Will pond. Can withstand traffic.
Catch basin filters	Yes	Paved or Earthen	Frequent maintenance required.
<b>Curb Inlet Protection</b>			
Curb inlet protection with wooden weir	Small capacity overflow	Paved	Used for sturdy, more compact installation.
Block and gravel curb inlet protection	Yes	Paved	Sturdy, but limited filtration.
<b>Culvert Inlet Protection</b>			
Culvert inlet sediment trap	N/A	N/A	18 month expected life.

## ***Design and Installation Specifications***

### **Excavated Drop Inlet Protection**

Excavated drop inlet protection consists of an excavated impoundment around the storm drain inlet. Sediment settles out of the stormwater prior to entering the storm drain. Design and installation specifications for excavated drop inlet protection include:

- Provide a depth of 1-2 ft as measured from the crest of the inlet structure.
- Slope sides of excavation should be no steeper than 2H:1V.
- Minimum volume of excavation is 35 cubic yards.
- Shape the excavation to fit the site, with the longest dimension oriented toward the longest inflow area.
- Install provisions for draining to prevent standing water.
- Clear the area of all debris.



- Grade the approach to the inlet uniformly.
- Drill weep holes into the side of the inlet.
- Protect weep holes with screen wire and washed aggregate.
- Seal weep holes when removing structure and stabilizing area.
- Build a temporary dike, if necessary, to the down slope side of the structure to prevent bypass flow.

### **Block and Gravel Filter**

A block and gravel filter is a barrier formed around the inlet with standard concrete blocks and gravel. See [Figure II-3.17: Block and Gravel Filter](#). Design and installation specifications for block gravel filters include:

- Provide a height of 1 to 2 feet above the inlet.
- Recess the first row of blocks 2-inches into the ground for stability.
- Support subsequent courses by placing a pressure treated wood 2x4 through the block opening.
- Do not use mortar.
- Lay some blocks in the bottom row on their side to allow for dewatering the pool.
- Place hardware cloth or comparable wire mesh with ½-inch openings over all block openings.
- Place gravel to just below the top of blocks on slopes of 2H:1V or flatter.
- An alternative design is a gravel berm surrounding the inlet, as follows:
  - Provide a slope of 3H:1V on the upstream side of the berm.
  - Provide a slope of 2H:1V on the downstream side of the berm.
  - Provide a 1-foot wide level stone area between the gravel berm and the inlet.
  - Use stones 3 inches in diameter or larger on the upstream slope of the berm.
  - Use gravel ½- to ¾-inch at a minimum thickness of 1-foot on the downstream slope of the berm.

**Figure II-3.17: Block and Gravel Filter**

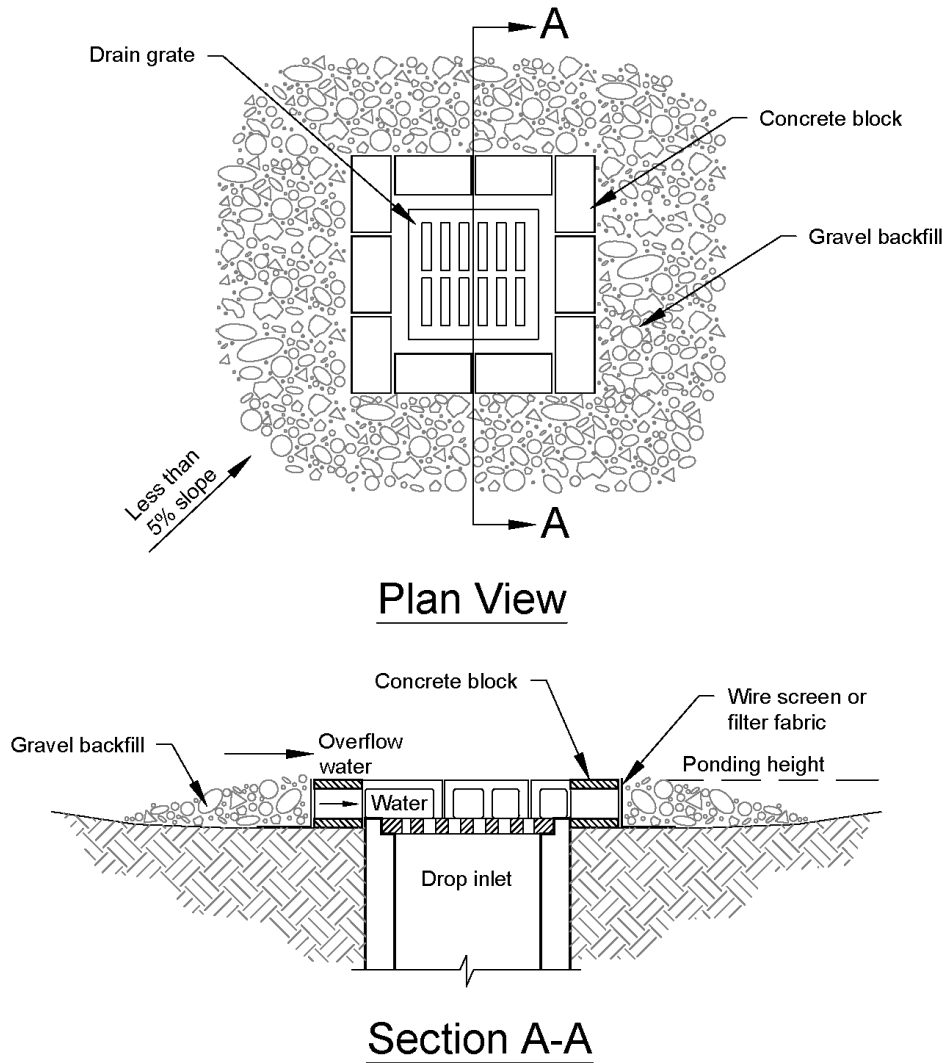

**Notes:**

1. Drop inlet sediment barriers are to be used for small, nearly level drainage areas. (less than 5%)
2. Excavate a basin of sufficient size adjacent to the drop inlet.
3. The top of the structure (poning height) must be well below the ground elevation downslope to prevent runoff from bypassing the inlet. A temporary dike may be necessary on the downslope side of the structure.

NOT TO SCALE



**Block and Gravel Filter**

Revised June 2016

Please see <http://www.ecy.wa.gov/copyright.html> for copyright notice including permissions, limitation of liability, and disclaimer.

### **Gravel and Wire Mesh Filter**

Gravel and wire mesh filters are gravel barriers placed over the top of the inlet. This method does not provide an overflow. Design and installation specifications for gravel and wire mesh filters include:

- Use a hardware cloth or comparable wire mesh with ½-inch openings.
  - Place wire mesh over the drop inlet so that the wire extends a minimum of 1-foot beyond each side of the inlet structure.
  - Overlap the strips if more than one strip of mesh is necessary.
- Place coarse aggregate over the wire mesh.
  - Provide at least a 12-inch depth of aggregate over the entire inlet opening and extend at least 18-inches on all sides.

### **Catch Basin Filters**

Catch basin filters are designed by manufacturers for construction sites. The limited sediment storage capacity increases the amount of inspection and maintenance required, which may be daily for heavy sediment loads. To reduce maintenance requirements, combine a catch basin filter with another type of inlet protection. This type of inlet protection provides flow bypass without overflow and therefore may be a better method for inlets located along active rights-of-way. Design and installation specifications for catch basin filters include:

- Provides 5 cubic feet of storage.
- Requires dewatering provisions.
- Provides a high-flow bypass that will not clog under normal use at a construction site.
- Insert the catch basin filter in the catch basin just below the grating.

### **Curb Inlet Protection with Wooden Weir**

Curb inlet protection with wooden weir is an option that consists of a barrier formed around a curb inlet with a wooden frame and gravel. Design and installation specifications for curb inlet protection with wooden weirs include:

- Use wire mesh with ½-inch openings.
- Use extra strength filter cloth.
- Construct a frame.
- Attach the wire and filter fabric to the frame.
- Pile coarse washed aggregate against the wire and fabric.
- Place weight on the frame anchors.

### **Block and Gravel Curb Inlet Protection**

Block and gravel curb inlet protection is a barrier formed around a curb inlet with concrete blocks and gravel. See [Figure II-3.18: Block and Gravel Curb Inlet Protection](#). Design and installation specifications for block and gravel curb inlet protection include:

- Use wire mesh with ½-inch openings.
- Place two concrete blocks on their sides abutting the curb at either side of the inlet opening. These are spacer blocks.
- Place a 2x4 stud through the outer holes of each spacer block to align the front blocks.
- Place blocks on their sides across the front of the inlet and abutting the spacer blocks.
- Place wire mesh over the outside vertical face.
- Pile coarse aggregate against the wire to the top of the barrier.

**Figure II-3.18: Block and Gravel Curb Inlet Protection**

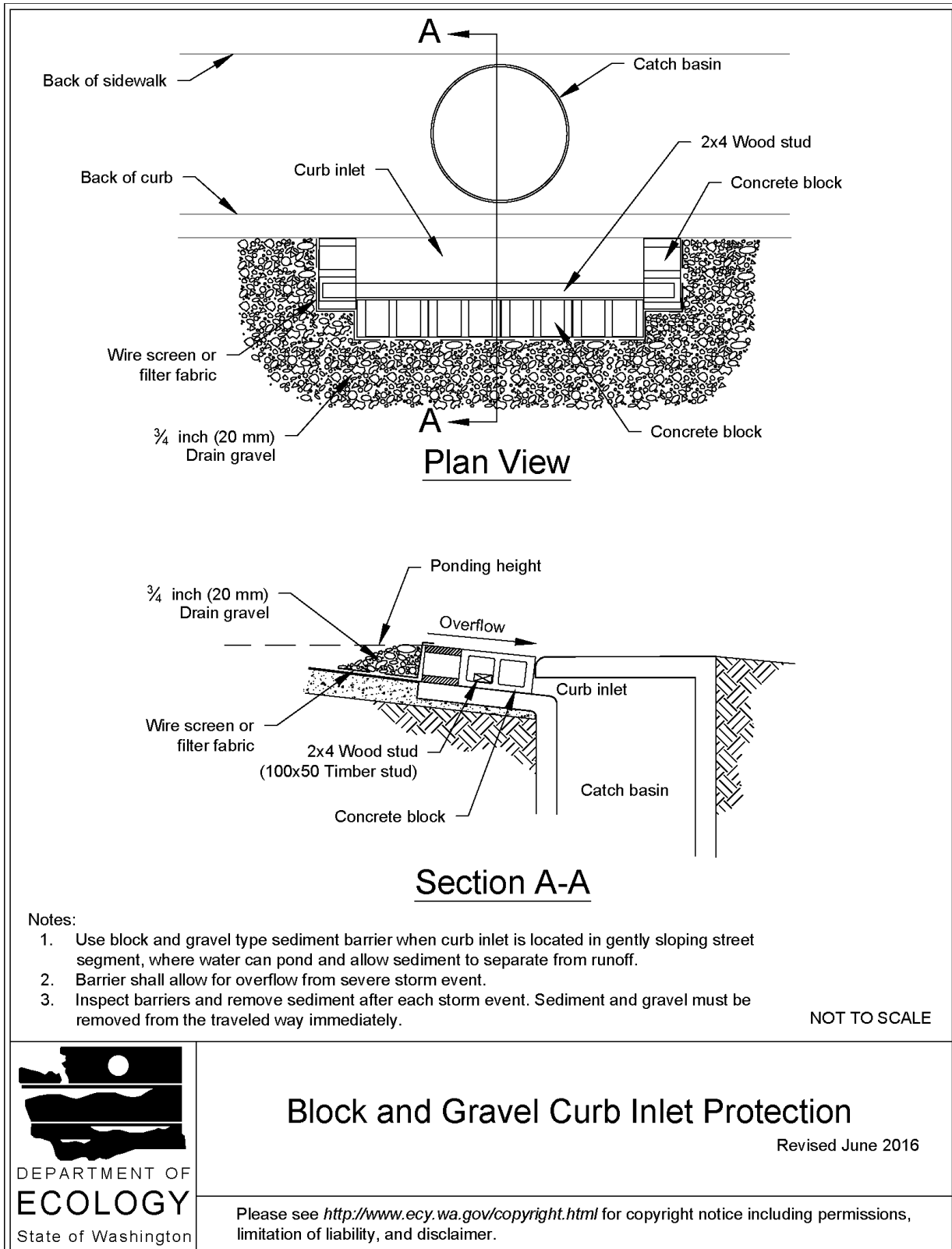

### **Curb and Gutter Sediment Barrier**

Curb and gutter sediment barrier is a sandbag or rock berm (riprap and aggregate) 3 feet high and 3 feet wide in a horseshoe shape. See [Figure II-3.19: Curb and Gutter Barrier](#). Design and installation specifications for curb and gutter sediment barrier include:

- Construct a horseshoe shaped berm, faced with coarse aggregate if using riprap, 3 feet high and 3 feet wide, at least 2 feet from the inlet.
- Construct a horseshoe shaped sedimentation trap on the upstream side of the berm. Size the trap to sediment trap standards for protecting a culvert inlet.

**Figure II-3.19: Curb and Gutter Barrier**

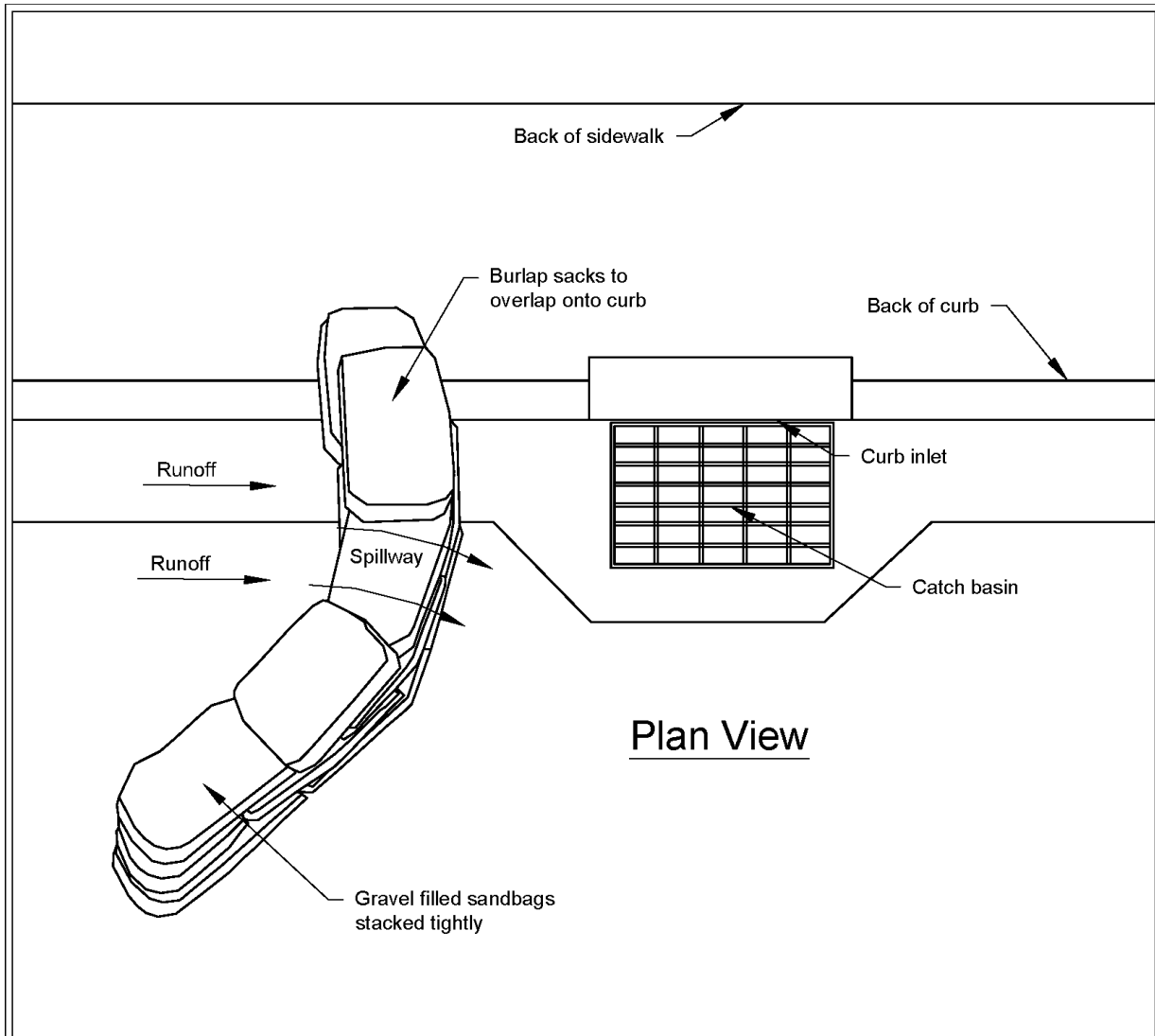

Plan View

**Notes:**

1. Place curb type sediment barriers on gently sloping street segments, where water can pond and allow sediment to separate from runoff.
2. Sandbags of either burlap or woven 'geotextile' fabric, are filled with gravel, layered and packed tightly.
3. Leave a one sandbag gap in the top row to provide a spillway for overflow.
4. Inspect barriers and remove sediment after each storm event. Sediment and gravel must be removed from the traveled way immediately.

NOT TO SCALE



**Curb and Gutter Barrier**

Revised June 2016

Please see <http://www.ecy.wa.gov/copyright.html> for copyright notice including permissions, limitation of liability, and disclaimer.

## ***Maintenance Standards***

- Inspect all forms of inlet protection frequently, especially after storm events. Clean and replace clogged catch basin filters. For rock and gravel filters, pull away the rocks from the inlet and clean or replace. An alternative approach would be to use the clogged rock as fill and put fresh rock around the inlet.
- Do not wash sediment into storm drains while cleaning. Spread all excavated material evenly over the surrounding land area or stockpile and stabilize as appropriate.

## ***Approved as Functionally Equivalent***

Ecology has approved products as able to meet the requirements of this BMP. The products did not pass through the Technology Assessment Protocol – Ecology (TAPE) process. Local jurisdictions may choose not to accept these products, or may require additional testing prior to consideration for local use. Products that Ecology has approved as functionally equivalent are available for review on Ecology's website at:

<https://ecology.wa.gov/Regulations-Permits/Guidance-technical-assistance/Stormwater-permittee-guidance-resources/Emerging-stormwater-treatment-technologies>



## **BMP C233: Silt Fence**

### ***Purpose***

Silt fence reduces the transport of coarse sediment from a construction site by providing a temporary physical barrier to sediment and reducing the runoff velocities of overland flow.

### ***Conditions of Use***

Silt fence may be used downslope of all disturbed areas.

- Silt fence shall prevent sediment carried by runoff from going beneath, through, or over the top of the silt fence, but shall allow the water to pass through the fence.
- Silt fence is not intended to treat concentrated flows, nor is it intended to treat substantial amounts of overland flow. Convey any concentrated flows through the drainage system to a sediment trapping BMP.
- Do not construct silt fences in streams or use in V-shaped ditches. Silt fences do not provide an adequate method of silt control for anything deeper than sheet or overland flow.

**Figure II-3.22: Silt Fence**

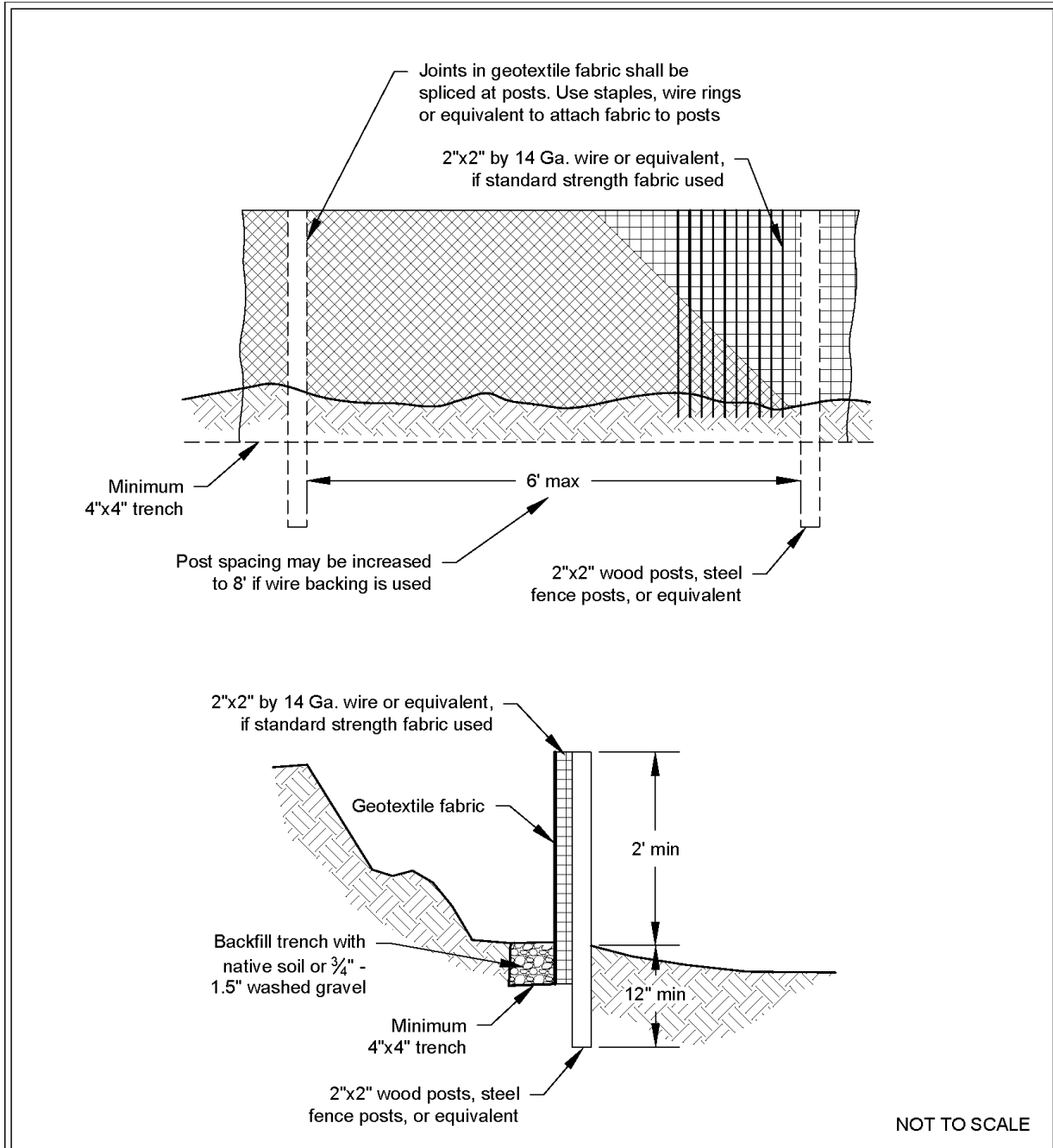

**Silt Fence**

Revised July 2017

Please see <http://www.ecy.wa.gov/copyright.html> for copyright notice including permissions, limitation of liability, and disclaimer.

## Design and Installation Specifications

- Use in combination with other construction stormwater BMPs.
- Maximum slope steepness (perpendicular to the silt fence line) 1H:1V.
- Maximum sheet or overland flow path length to the silt fence of 100 feet.
- Do not allow flows greater than 0.5 cfs.
- Use geotextile fabric that meets the following standards. All geotextile properties listed below are minimum average roll values (i.e., the test result for any sampled roll in a lot shall meet or exceed the values shown in [Table II-3.11: Geotextile Fabric Standards for Silt Fence](#)):

**Table II-3.11: Geotextile Fabric Standards for Silt Fence**

Geotextile Property	Minimum Average Roll Value
Polymeric Mesh AOS (ASTM D4751)	0.60 mm maximum for slit film woven (#30 sieve). 0.30 mm maximum for all other geotextile types (#50 sieve). 0.15 mm minimum for all fabric types (#100 sieve).
Water Permittivity (ASTM D4491)	0.02 sec <sup>-1</sup> minimum
Grab Tensile Strength (ASTM D4632)	180 lbs. Minimum for extra strength fabric. 100 lbs minimum for standard strength fabric.
Grab Tensile Strength (ASTM D4632)	30% maximum
Ultraviolet Resistance (ASTM D4355)	70% minimum

- Support standard strength geotextiles with wire mesh, chicken wire, 2-inch x 2-inch wire, safety fence, or jute mesh to increase the strength of the geotextile. Silt fence materials are available that have synthetic mesh backing attached.
- Silt fence material shall contain ultraviolet ray inhibitors and stabilizers to provide a minimum of six months of expected usable construction life at a temperature range of 0°F to 120°F.
- One-hundred percent biodegradable silt fence is available that is strong, long lasting, and can be left in place after the project is completed, if permitted by the local jurisdiction.
- Refer to [Figure II-3.22: Silt Fence](#) for standard silt fence details. Include the following Standard Notes for silt fence on construction plans and specifications:
  1. The Contractor shall install and maintain temporary silt fences at the locations shown in the Plans.
  2. Construct silt fences in areas of clearing, grading, or drainage prior to starting those activities.

3. The silt fence shall have a 2-foot min. and a 2½-foot max. height above the original ground surface.
4. The geotextile fabric shall be sewn together at the point of manufacture to form fabric lengths as required. Locate all sewn seams at support posts. Alternatively, two sections of silt fence can be overlapped, provided that the overlap is long enough and that the adjacent silt fence sections are close enough together to prevent silt laden water from escaping through the fence at the overlap.
5. Attach the geotextile fabric on the up-slope side of the posts and secure with staples, wire, or in accordance with the manufacturer's recommendations. Attach the geotextile fabric to the posts in a manner that reduces the potential for tearing.
6. Support the geotextile fabric with wire or plastic mesh, dependent on the properties of the geotextile selected for use. If wire or plastic mesh is used, fasten the mesh securely to the up-slope side of the posts with the geotextile fabric up-slope of the mesh.
7. Mesh support, if used, shall consist of steel wire with a maximum mesh spacing of 2-inches, or a prefabricated polymeric mesh. The strength of the wire or polymeric mesh shall be equivalent to or greater than 180 lbs. grab tensile strength. The polymeric mesh must be as resistant to the same level of ultraviolet radiation as the geotextile fabric it supports.
8. Bury the bottom of the geotextile fabric 4-inches min. below the ground surface. Backfill and tamp soil in place over the buried portion of the geotextile fabric, so that no flow can pass beneath the silt fence and scouring cannot occur. When wire or polymeric back-up support mesh is used, the wire or polymeric mesh shall extend into the ground 3-inches min.
9. Drive or place the silt fence posts into the ground 18-inches min. A 12-inch min. depth is allowed if topsoil or other soft subgrade soil is not present and 18-inches cannot be reached. Increase fence post min. depths by 6 inches if the fence is located on slopes of 3H:1V or steeper and the slope is perpendicular to the fence. If required post depths cannot be obtained, the posts shall be adequately secured by bracing or guying to prevent overturning of the fence due to sediment loading.
10. Use wood, steel or equivalent posts. The spacing of the support posts shall be a maximum of 6-feet. Posts shall consist of either:
  - Wood with minimum dimensions of 2 inches by 2 inches by 3 feet. Wood shall be free of defects such as knots, splits, or gouges.
  - No. 6 steel rebar or larger.
  - ASTM A 120 steel pipe with a minimum diameter of 1-inch.
  - U, T, L, or C shape steel posts with a minimum weight of 1.35 lbs./ft.
  - Other steel posts having equivalent strength and bending resistance to the post sizes listed above.
11. Locate silt fences on contour as much as possible, except at the ends of the fence,

where the fence shall be turned uphill such that the silt fence captures the runoff water and prevents water from flowing around the end of the fence.

12. If the fence must cross contours, with the exception of the ends of the fence, place check dams perpendicular to the back of the fence to minimize concentrated flow and erosion. The slope of the fence line where contours must be crossed shall not be steeper than 3H:1V.
  - Check dams shall be approximately 1-foot deep at the back of the fence. Check dams shall be continued perpendicular to the fence at the same elevation until the top of the check dam intercepts the ground surface behind the fence.
  - Check dams shall consist of crushed surfacing base course, gravel backfill for walls, or shoulder ballast. Check dams shall be located every 10 feet along the fence where the fence must cross contours.
- Refer to [Figure II-3.23: Silt Fence Installation by Slicing Method](#) for slicing method details. The following are specifications for silt fence installation using the slicing method:
  1. The base of both end posts must be at least 2- to 4-inches above the top of the geotextile fabric on the middle posts for ditch checks to drain properly. Use a hand level or string level, if necessary, to mark base points before installation.
  2. Install posts 3- to 4-feet apart in critical retention areas and 6- to 7-feet apart in standard applications.
  3. Install posts 24-inches deep on the downstream side of the silt fence, and as close as possible to the geotextile fabric, enabling posts to support the geotextile fabric from upstream water pressure.
  4. Install posts with the nipples facing away from the geotextile fabric.
  5. Attach the geotextile fabric to each post with three ties, all spaced within the top 8-inches of the fabric. Attach each tie diagonally 45 degrees through the fabric, with each puncture at least 1-inch vertically apart. Each tie should be positioned to hang on a post nipple when tightening to prevent sagging.
  6. Wrap approximately 6-inches of the geotextile fabric around the end posts and secure with 3 ties.
  7. No more than 24-inches of a 36-inch geotextile fabric is allowed above ground level.
  8. Compact the soil immediately next to the geotextile fabric with the front wheel of the tractor, skid steer, or roller exerting at least 60 pounds per square inch. Compact the upstream side first and then each side twice for a total of four trips. Check and correct the silt fence installation for any deviation before compaction. Use a flat-bladed shovel to tuck the fabric deeper into the ground if necessary.

**Figure II-3.23: Silt Fence Installation by Slicing Method**

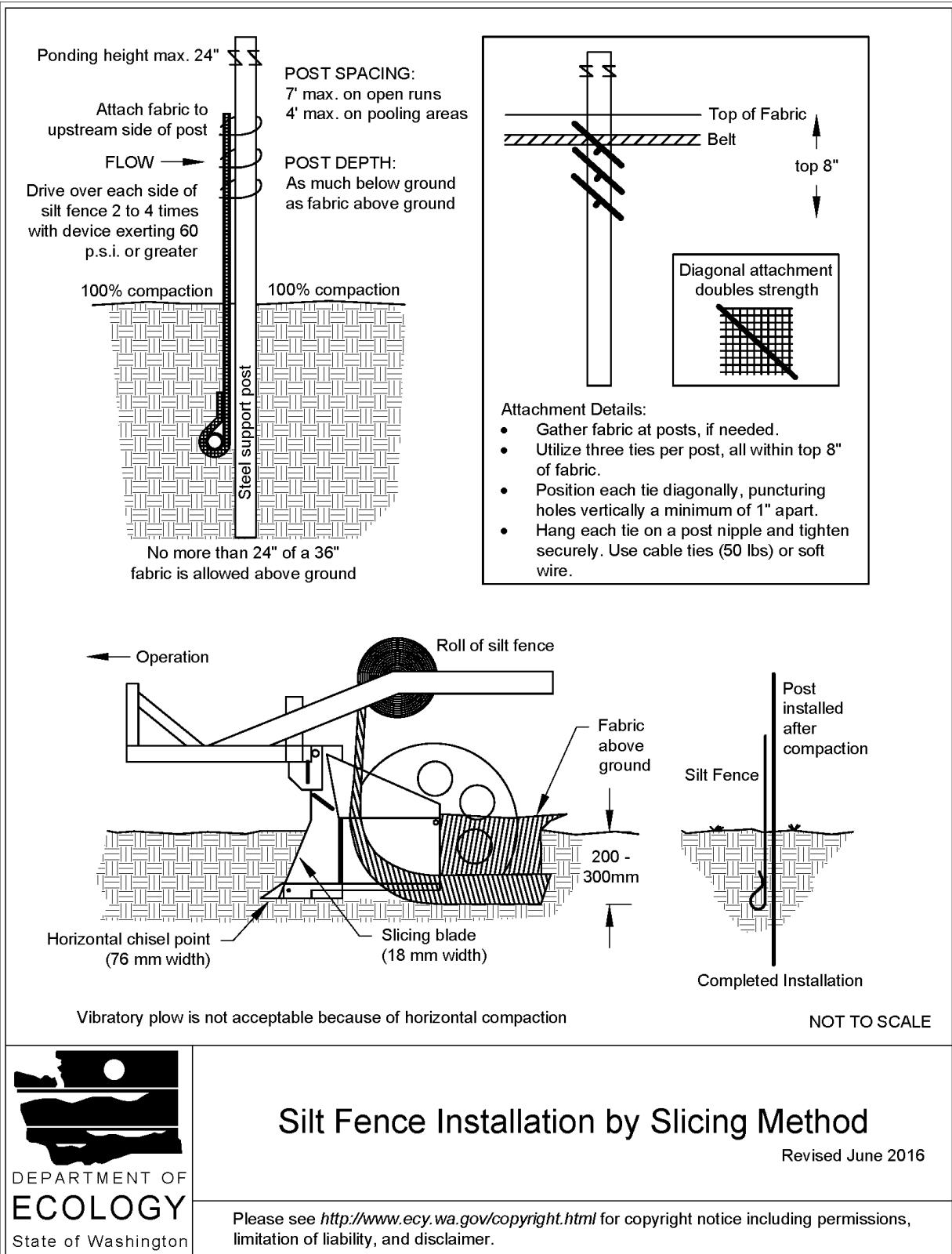

## ***Maintenance Standards***

- Repair any damage immediately.
- Intercept and convey all evident concentrated flows uphill of the silt fence to a sediment trapping BMP.
- Check the uphill side of the silt fence for signs of the fence clogging and acting as a barrier to flow and then causing channelization of flows parallel to the fence. If this occurs, replace the fence and remove the trapped sediment.
- Remove sediment deposits when the deposit reaches approximately one-third the height of the silt fence, or install a second silt fence.
- Replace geotextile fabric that has deteriorated due to ultraviolet breakdown.

## **BMP C240: Sediment Trap**

### ***Purpose***

A sediment trap is a small temporary ponding area with a gravel outlet used to collect and store sediment from sites during construction. Sediment traps, along with other perimeter controls, shall be installed before any land disturbance takes place in the drainage area.

### ***Conditions of Use***

- Sediment traps are intended for use on sites where the tributary drainage area is less than 3 acres, with no unusual drainage features, and a projected build-out time of six months or less. The sediment trap is a temporary measure (with a design life of approximately 6 months) and shall be maintained until the tributary area is permanently protected against erosion by vegetation and/or structures.
- Sediment traps are only effective in removing sediment down to about the medium silt size fraction. Runoff with sediment of finer grades (fine silt and clay) will pass through untreated, emphasizing the need to control erosion to the maximum extent first.
- Projects that are constructing permanent Flow Control BMPs, or Runoff Treatment BMPs that use ponding for treatment, may use the rough-graded or final-graded permanent BMP footprint for the temporary sediment trap. When permanent BMP footprints are used as temporary sediment traps, the surface area requirement of the sediment trap must be met. If the surface area requirement of the sediment trap is larger than the surface area of the permanent BMP, then the sediment trap shall be enlarged beyond the permanent BMP footprint to comply with the surface area requirement.



- A floating pond skimmer may be used for the sediment trap outlet if approved by the Local Permitting Authority.
- Sediment traps may not be feasible on utility projects due to the limited work space or the short-term nature of the work. Portable tanks may be used in place of sediment traps for utility projects.

## ***Design and Installation Specifications***

- See [Figure II-3.26: Cross Section of Sediment Trap](#) and [Figure II-3.27: Sediment Trap Outlet](#) for details.
- To determine the sediment trap geometry, first calculate the design surface area (SA) of the trap, measured at the invert of the weir. Use the following equation:

$$SA = FS(Q_2/V_s)$$

where

$Q_2 =$

- Option 1 - Single Event Hydrograph Method:

$Q_2$  = Peak volumetric flow rate calculated using a 10-minute time step from a Type 1A, 2-year, 24-hour frequency storm for the developed condition. The 10-year peak volumetric flow rate shall be used if the project size, expected timing and duration of construction, or downstream conditions warrant a higher level of protection.

- Option 2 - For construction sites that are less than 1 acre, the Rational Method may be used to determine  $Q_2$ .

$V_s$  = The settling velocity of the soil particle of interest. The 0.02 mm (medium silt) particle with an assumed density of 2.65 g/cm<sup>3</sup> has been selected as the particle of interest and has a settling velocity ( $V_s$ ) of 0.00096 ft/sec.

FS = A safety factor of 2 to account for non-ideal settling.

Therefore, the equation for computing sediment trap surface area becomes:

$$SA = 2 \times Q_2 / 0.00096$$

or

2080 square feet per cfs of inflow

- Sediment trap depth shall be 3.5 feet minimum from the bottom of the trap to the top of the overflow weir.
- To aid in determining sediment depth, all sediment traps shall have a staff gauge with a prominent mark 1-foot above the bottom of the trap.

- Design the discharge from the sediment trap by using the guidance for discharge from temporary sediment ponds in [BMP C241: Sediment Pond \(Temporary\)](#).

### ***Maintenance Standards***

- Sediment shall be removed from the trap when it reaches 1-foot in depth.
- Any damage to the trap embankments or slopes shall be repaired.

**Figure II-3.26: Cross Section of Sediment Trap**

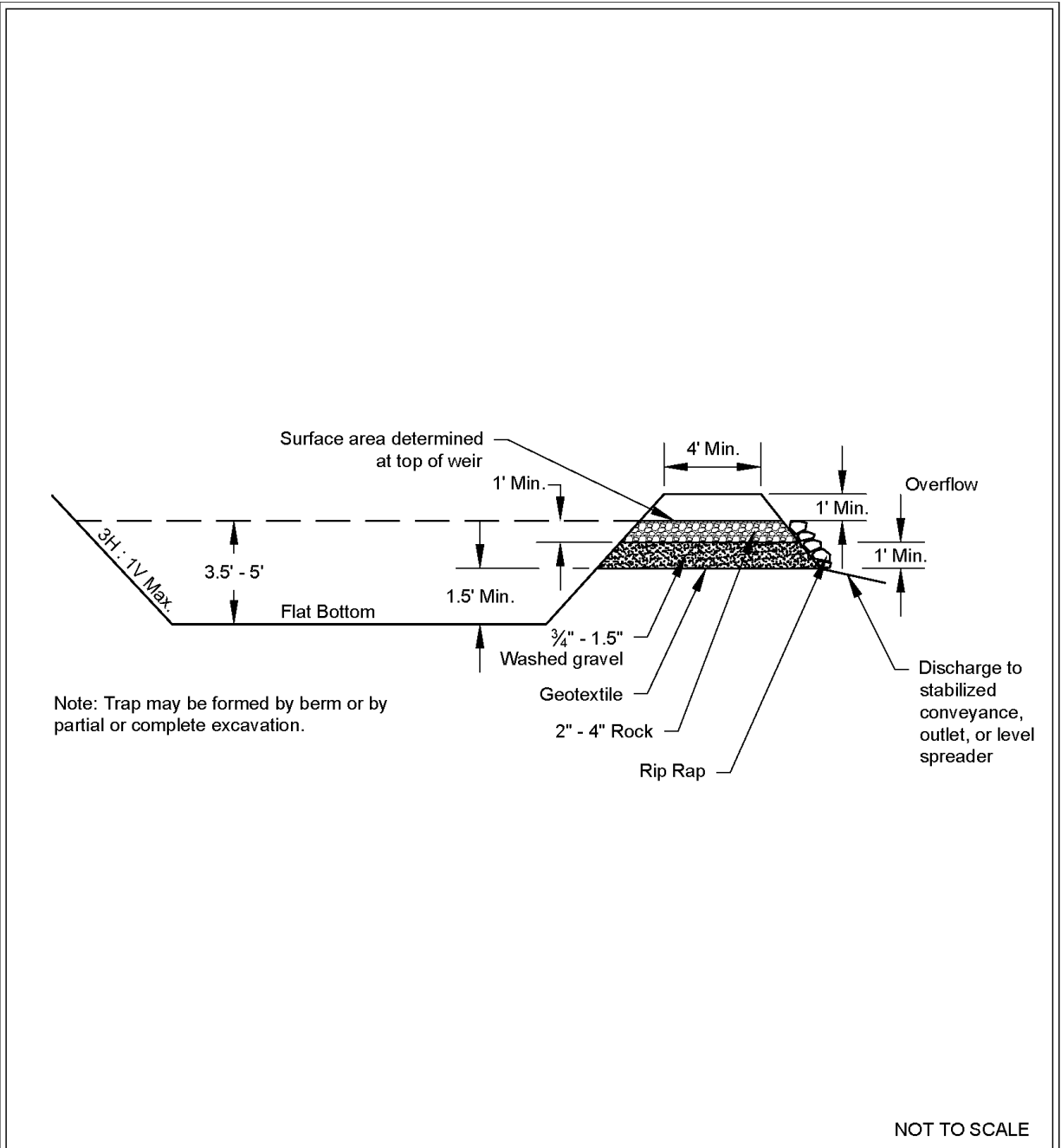

**Cross Section of Sediment Trap**

Revised June 2016

Please see <http://www.ecy.wa.gov/copyright.html> for copyright notice including permissions, limitation of liability, and disclaimer.

**Figure II-3.27: Sediment Trap Outlet**

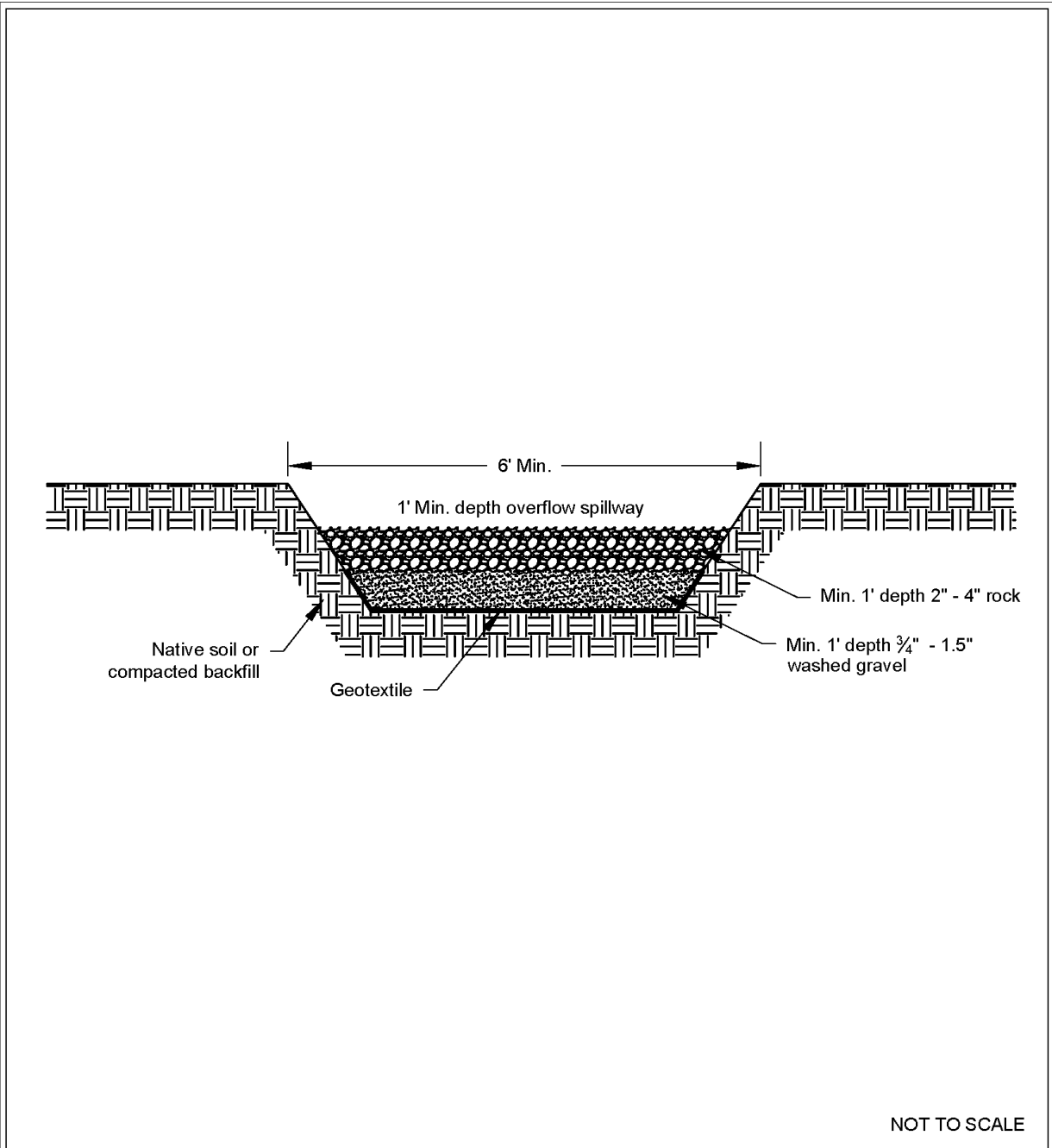

## Sediment Trap Outlet

Revised June 2016

Please see <http://www.ecy.wa.gov/copyright.html> for copyright notice including permissions, limitation of liability, and disclaimer.

## **BMP C252: Treating and Disposing of High pH Water**

### ***Purpose***

When pH levels in stormwater rise above 8.5, it is necessary to lower the pH levels to the acceptable range of 6.5 to 8.5 prior to discharge to surface or ground water. A pH level range of 6.5 to 8.5 is typical for most natural watercourses, and this neutral pH range is required for the survival of aquatic organisms. Should the pH rise or drop out of this range, fish and other aquatic organisms may become stressed and may die.

### ***Conditions of Use***

- The water quality standard for pH in Washington State is in the range of 6.5 to 8.5. Stormwater with pH levels exceeding water quality standards may be either neutralized on site or disposed of to a sanitary sewer or concrete batch plant with pH neutralization capabilities.
- Neutralized stormwater may be discharged to surface waters under the Construction Stormwater General permit.
- Neutralized process water such as concrete truck wash-out, hydro-demolition, or saw-cutting slurry must be managed to prevent discharge to surface waters. Any stormwater

contaminated during concrete work is considered process wastewater and must not be discharged to waters of the State or stormwater collection systems.

- The process used for neutralizing and/or disposing of high pH stormwater from the site must be documented in the Construction Stormwater Pollution Prevention Plan.

## ***Causes of High pH***

High pH at construction sites is most commonly caused by the contact of stormwater with poured or recycled concrete, cement, mortars, and other Portland cement or lime containing construction materials. (See [BMP C151: Concrete Handling](#) for more information on concrete handling procedures). The principal caustic agent in cement is calcium hydroxide (free lime).

Calcium hardness can contribute to high pH values and cause toxicity that is associated with high pH conditions. A high level of calcium hardness in waters of the state is not allowed. Ground water standard for calcium and other dissolved solids in Washington State is less than 500 mg/l.

## ***Treating High pH Stormwater by Carbon Dioxide Sparging***

### **Advantages of Carbon Dioxide Sparging**

- Rapidly neutralizes high pH water.
- Cost effective and safer to handle than acid compounds.
- CO<sub>2</sub> is self-buffering. It is difficult to overdose and create harmfully low pH levels.
- Material is readily available.

### **The Chemical Process of Carbon Dioxide Sparging**

When carbon dioxide (CO<sub>2</sub>) is added to water (H<sub>2</sub>O), carbonic acid (H<sub>2</sub>CO<sub>3</sub>) is formed which can further dissociate into a proton (H<sup>+</sup>) and a bicarbonate anion (HCO<sub>3</sub><sup>-</sup>) as shown below:



The free proton is a weak acid that can lower the pH. Water temperature has an effect on the reaction as well. The colder the water temperature is, the slower the reaction occurs. The warmer the water temperature is, the quicker the reaction occurs. Most construction applications in Washington State have water temperatures in the 50°F or higher range so the reaction is almost simultaneous.

### **The Treatment Process of Carbon Dioxide Sparging**

High pH water may be treated using continuous treatment, continuous discharge systems. These manufactured systems continuously monitor influent and effluent pH to ensure that pH values are within an acceptable range before being discharged. All systems must have fail safe automatic shut off switches in the event that pH is not within the acceptable discharge range. Only trained operators may operate manufactured systems. System manufacturers often provide trained operators or training on their devices.

The following procedure may be used when not using a continuous discharge system:

1. Prior to treatment, the appropriate jurisdiction should be notified in accordance with the regulations set by the jurisdiction.
2. Every effort should be made to isolate the potential high pH water in order to treat it separately from other stormwater on-site.
3. Water should be stored in an acceptable storage facility, detention pond, or containment cell prior to pH treatment.
4. Transfer water to be treated for pH to the pH treatment structure. Ensure that the pH treatment structure size is sufficient to hold the amount of water that is to be treated. Do not fill the pH treatment structure completely, allow at least 2 feet of freeboard.
5. The operator samples the water within the pH treatment structure for pH and notes the clarity of the water. As a rule of thumb, less CO<sub>2</sub> is necessary for clearer water. The results of the samples and water clarity observations should be recorded.
6. In the pH treatment structure, add CO<sub>2</sub> until the pH falls into the range of 6.9-7.1. Adjusting pH to within 0.2 pH units of receiving water (background pH) is recommended. It is unlikely that pH can be adjusted to within 0.2 pH units using dry ice. Compressed carbon dioxide gas should be introduced to the water using a carbon dioxide diffuser located near the bottom of the pH treatment structure, this will allow carbon dioxide to bubble up through the water and diffuse more evenly.
7. Slowly discharge the water, making sure water does not get stirred up in the process. Release about 80% of the water from the pH treatment structure leaving any sludge behind. If turbidity remains above the maximum allowable, consider adding filtration to the treatment train. See [BMP C251: Construction Stormwater Filtration](#).
8. Discharge treated water through a pond or drainage system.
9. Excess sludge needs to be disposed of properly as concrete waste. If several batches of water are undergoing pH treatment, sludge can be left in the treatment structure for the next batch treatment. Dispose of sludge when it fills 50% of the treatment structure volume.
10. Disposal must comply with applicable local, state, and federal regulations.

### ***Treating High pH Stormwater by Food Grade Vinegar***

Food grade vinegar that meets FDA standards may be used to neutralize high pH water. Food grade vinegar is only 4% to 18% acetic acid with the remainder being water. Food grade vinegar may be used if dosed just enough to lower pH sufficiently. Use a treatment process as described above for CO<sub>2</sub> sparging, but add food grade vinegar instead of CO<sub>2</sub>.

This treatment option for high pH stormwater does not apply to anything but food grade vinegar. Acetic acid does not equal vinegar. Any other product or waste containing acetic acid must go through the evaluation process in Appendix G of *Whole Effluent Toxicity Testing Guidance and Test Review Criteria* ([Marshall, 2016](#)).

## ***Disposal of High pH Stormwater***

### **Sanitary Sewer Disposal**

Local sewer authority approval is required prior to disposal via the sanitary sewer.

### **Concrete Batch Plant Disposal**

- Only permitted facilities may accept high pH water.
- Contact the facility to ensure they can accept the high pH water.

## ***Maintenance Standards***

Safety and materials handling:

- All equipment should be handled in accordance with OSHA rules and regulations.
- Follow manufacturer guidelines for materials handling.

Each operator should provide:

- A diagram of the monitoring and treatment equipment.
- A description of the pumping rates and capacity the treatment equipment is capable of treating.

Each operator should keep a written record of the following:

- Client name and phone number.
- Date of treatment.
- Weather conditions.
- Project name and location.
- Volume of water treated.
- pH of untreated water.
- Amount of CO<sub>2</sub> or food grade vinegar needed to adjust water to a pH range of 6.9-7.1.
- pH of treated water.
- Discharge point location and description.

A copy of this record should be given to the client/contractor who should retain the record for three years.



## **C. Correspondence**

## **D. Site Inspection Form**

## Site Inspection Report

Site Name: \_\_\_\_\_ Inspection Area: \_\_\_\_\_

Division: \_\_\_\_\_ Inspection Date: \_\_\_\_\_ Inspector: \_\_\_\_\_

Permits: \_\_\_\_\_

Land Parcels: \_\_\_\_\_

Weather Conditions (check one):  Dry  Rain  Snow  Icy

Inspection Type (check one):  Regular  Final

Rainfall Amount at Time of Inspection: \_\_\_\_\_ (in inches)

Rainfall Duration: \_\_\_\_\_ (in hours)  Pre-Storm

<b>General</b>		<b>Yes</b>	<b>No</b>	<b>N/A</b>
A.	Is the Storm Water Plan ("SWP") on site or its location posted?	<input type="checkbox"/>	<input type="checkbox"/>	<input type="checkbox"/>
B.	If required, are the Applicable Permit and/or NOI on site?	<input type="checkbox"/>	<input type="checkbox"/>	<input type="checkbox"/>
C.	Is contact information for the Site Storm Water Compliance Representatives provided on site and is it correct?	<input type="checkbox"/>	<input type="checkbox"/>	<input type="checkbox"/>
D.	Since the last inspection, has Toll Brothers received written notice of a federal, state, or local inspection evaluating compliance with the Applicable Permit?	<input type="checkbox"/>	<input type="checkbox"/>	<input type="checkbox"/>
E.	Was the Site Inspection Report for the last inspection signed by the Site Storm Water Compliance Representative and certified if and as required by the Applicable Permit?	<input type="checkbox"/>	<input type="checkbox"/>	<input type="checkbox"/>

<b>Maintenance</b>		<b>Yes</b>	<b>No</b>	<b>N/A</b>
F.	Is there an excess of sediment or other pollutants exiting the site?	<input type="checkbox"/>	<input type="checkbox"/>	<input type="checkbox"/>
G.	Are off-site roads/gutters free of excessive sediment from the site?	<input type="checkbox"/>	<input type="checkbox"/>	<input type="checkbox"/>
H.	Are exit/entrance controls properly located and in working condition, with no maintenance necessary?	<input type="checkbox"/>	<input type="checkbox"/>	<input type="checkbox"/>
I.	Are exposed areas stabilized as required?	<input type="checkbox"/>	<input type="checkbox"/>	<input type="checkbox"/>
J.	Are stockpiles located and stabilized as required?	<input type="checkbox"/>	<input type="checkbox"/>	<input type="checkbox"/>
K.	Are other BMPs properly located, in working condition, and no repairs necessary?	<input type="checkbox"/>	<input type="checkbox"/>	<input type="checkbox"/>
L.	Are concrete, paint, and stucco washout areas properly located, in working condition, and no maintenance necessary?	<input type="checkbox"/>	<input type="checkbox"/>	<input type="checkbox"/>
M.	Are hazardous materials managed as required?	<input type="checkbox"/>	<input type="checkbox"/>	<input type="checkbox"/>
N.	Are trash, construction debris, and other solid wastes managed as required; and on-site roads/gutters free of excessive sediment?	<input type="checkbox"/>	<input type="checkbox"/>	<input type="checkbox"/>
O.	Are portable toilets properly located and maintained?	<input type="checkbox"/>	<input type="checkbox"/>	<input type="checkbox"/>
P.	Are the Site Storm Water BMPs and the SWP consistent with each other?	<input type="checkbox"/>	<input type="checkbox"/>	<input type="checkbox"/>
Q.	Are there ruts, gullies, or other signs of accelerated erosion?	<input type="checkbox"/>	<input type="checkbox"/>	<input type="checkbox"/>
R.	Are there any other compliance issues, inadequate BMPs, additional BMPs, or improvements this Site should address?	<input type="checkbox"/>	<input type="checkbox"/>	<input type="checkbox"/>

Please note that this form must be kept with the Storm Water Plan ("SWP")

**Site Inspection Report**

Site Name: \_\_\_\_\_ Inspection Area: \_\_\_\_\_

Division: \_\_\_\_\_ Inspection Date: \_\_\_\_\_ Inspector: \_\_\_\_\_

Land Parcels: \_\_\_\_\_

Notes

**Responsive Action Log**

**Unaddressed Action Items from Previous Inspections**

Reference Number	Action Item and Location	Date Item Noted	Date Corrected	Due Date	Addressed By	Responsive Action Taken

**New Action Items**

Please note that this form must be kept with the Storm Water Plan ("SWP")

**Site Inspection Report**

Site Name: \_\_\_\_\_ Inspection Area: \_\_\_\_\_  
Division: \_\_\_\_\_ Inspection Date: \_\_\_\_\_ Inspector: \_\_\_\_\_  
Land Parcels: \_\_\_\_\_

INSERT CERTIFICATION IF AND AS REQUIRED BY THE APPLICABLE PERMIT

\_\_\_\_\_  
Name of Inspector Signature of Inspector Date

INSERT CERTIFICATION IF AND AS REQUIRED BY THE APPLICABLE PERMIT

**This form must be signed by a Site Storm Water Compliance Representative.**

\_\_\_\_\_  
Site Storm Water Compliance Representative Signature Date

Please note that this form must be kept with the Storm Water Plan ("SWP")

## Rain Event Site Inspection Report

Site Name: \_\_\_\_\_ Inspection Area: \_\_\_\_\_

Division: \_\_\_\_\_ Inspection Date: \_\_\_\_\_ Inspector: \_\_\_\_\_

Land Parcels: \_\_\_\_\_

Rainfall Amount at Time of Inspection: \_\_\_\_\_ (in inches)

Rainfall Duration: \_\_\_\_\_ (in hours)  Pre-Storm

**Walk through the entire construction area and look for**

- 1. pollutant discharges;**
- 2. excessive sediment on off-site roads and gutters;**
- 3. erosion control measures that may have failed or been damaged;**
- 4. ruts, gullies, or other signs of accelerated erosion;**
- 5. existing erosion control measures that are inadequate; and**
- 6. areas which require additional erosion control measures.**

<b>Maintenance</b>		<b>Yes</b>	<b>No</b>	<b>N/A</b>
F.	Is there an excess of sediment or other pollutants exiting the site?	<input type="checkbox"/>	<input type="checkbox"/>	<input checked="" type="checkbox"/>
G.	Are off-site roads/gutters free of excessive sediment from the site?	<input type="checkbox"/>	<input type="checkbox"/>	<input type="checkbox"/>
K.	Are other BMPs properly located, in working condition, and no repairs necessary?	<input type="checkbox"/>	<input type="checkbox"/>	<input type="checkbox"/>
Q.	Are there ruts, gullies, or other signs of accelerated erosion?	<input type="checkbox"/>	<input type="checkbox"/>	<input type="checkbox"/>
R.	Are there any other compliance issues, inadequate BMPs, additional BMPs, or improvements this Site should address?	<input type="checkbox"/>	<input type="checkbox"/>	<input type="checkbox"/>

<b>Notes</b>

### Responsive Action Log

#### Unaddressed Action Items from Previous Inspections

Reference Number	Action Item and Location	Date Item Noted	Date Corrected	Due Date	Addressed By	Responsive Action Taken

Please note that this form must be kept with the Storm Water Plan ("SWP")

**Rain Event Site Inspection Report**

Site Name: \_\_\_\_\_ Inspection Area: \_\_\_\_\_

Division: \_\_\_\_\_ Inspection Date: \_\_\_\_\_ Inspector: \_\_\_\_\_

Land Parcels: \_\_\_\_\_

**New Action Items**

Please note that this form must be kept with the Storm Water Plan ("SWP")

**Rain Event Site Inspection Report**

Site Name: \_\_\_\_\_ Inspection Area: \_\_\_\_\_  
Division: \_\_\_\_\_ Inspection Date: \_\_\_\_\_ Inspector: \_\_\_\_\_  
Land Parcels: \_\_\_\_\_

INSERT CERTIFICATION IF AND AS REQUIRED BY THE APPLICABLE PERMIT

\_\_\_\_\_  
Name of Inspector Signature of Inspector Date

INSERT CERTIFICATION IF AND AS REQUIRED BY THE APPLICABLE PERMIT

**This form must be signed by a Site Storm Water Compliance Representative.**

\_\_\_\_\_  
Site Storm Water Compliance Representative Signature Date

Please note that this form must be kept with the Storm Water Plan ("SWP")



# User Instructions for Site Inspection Report

## GENERAL INSTRUCTIONS

*These General Instructions describe the requirements for completion of the information and questions contained in the Site Inspection Report. There are separate instructions for access to and use of Toll Brothers' Storm Water Compliance reporting application.*

- This form consists of the Site Inspection Report and Responsive Action Log.
- Only the Site Storm Water Compliance Representative and his/her Designee, including a Storm Water Consultant, are permitted to undertake the inspection required by this form. If you are not this person, you must contact the Division Storm Water Compliance Representative immediately.
- Each Action Item must have a corresponding Responsive Action. An Action Item is a condition that requires action to be taken to achieve or maintain compliance with Storm Water Requirements. A Responsive Action is an action taken to address an Action Item or to achieve or maintain compliance with Storm Water Requirements.
- Before proceeding with any inspection, you must first verify that the immediately previous inspection was conducted and the Site Inspection Report was completed. You must also determine whether all Responsive Actions identified from the prior inspection (including any rain events), if any, were undertaken within the time period allowed by the Applicable Permit.
- You must restate or carry over to the current Responsive Action Log any Responsive Action not completed since the last Regular Inspection or Rain Event Inspection regardless of the time period allowed by the Applicable Permit. For each Responsive Action carried forward, you should make a note in the prior Responsive Action Log that the Responsive Action has been carried forward. **Do not leave any blanks in a prior Responsive Action Log.**
- You must answer every question. Check "Yes", "No", or "N/A" for each question as appropriate. A response of "N/A" is only permitted where the designated area under "N/A" is not blocked out.
- If you check "No" for Questions A, B, C, E, G, H, I, J, K, L, M, N, O, and/or P, or "Yes" for Questions D, F, Q, and/or R on the Site Inspection Report, you must provide a reference number under the "Reference Number" column on the Responsive Action Log for each Action Item identified. Reference Numbers have a letter and a number. The first character matches the letter designation of the applicable question. The second character is numerical starting with number 1. Responsive Action reference numbers shall be successive thereafter as to the numerical portion, for example, F-1, F-2, F-3... G-1, G-2... H-1, I-1, etc.
- You must sign and date the completed Site Inspection Report. If you are a Storm Water Consultant or a Designee for the Site Storm Water Compliance Representative and you complete this form, the Site Storm Water Compliance Representative must review and sign the completed form as well.

- A copy of each completed Site Inspection Report must be kept with the SWP.
- At the conclusion of the Site Inspection, submit the Inspection Report to the Toll Brothers' Storm Water Compliance intranet-based reporting application.
- You must record the following information on each Site Inspection Report:
  - ✓ Site Name. Insert the name of the Toll Brothers' Community.
  - ✓ Inspection Area. Enter the name of the portion(s) of the Site that is (are) being inspected.
  - ✓ Division. Insert the name of the Toll's operating division responsible for the Site identified on the form.
  - ✓ Inspection Date. Insert the date on which the inspection is being performed.
  - ✓ Inspector. Enter the name of the person performing the inspection.
  - ✓ Weather conditions. Check the appropriate description that best describes weather conditions during the inspection.
  - ✓ Type of Inspection. Check the inspection type that represents the purpose of the inspection. Only one inspection type may be checked. A Regular Inspection is one conducted according to the regular schedule of inspections for a Site, and includes rain event inspection information, when applicable. A Final Inspection is the last inspection planned prior to obtaining the Notice of Termination.
  - ✓ Rainfall Amount at Time of Inspection: Enter the total amount of rain (in inches) that has fallen for the rainfall event covered by the inspection.
  - ✓ Rainfall Duration: Enter the length of the rainfall event in hours.
  - ✓ Pre-Storm Box: Check this box if you are performing an inspection in advance of a predicted rainfall event. (California is the only state with the current requirement to perform a Pre-Storm Inspection.)

### **INSTRUCTIONS FOR COMPLETING INDIVIDUAL QUESTIONS**

- You must respond to all of the following questions on each and every Site Inspection Report:
  - A. **Is the Storm Water Plan (“SWP”) on site or its location posted?** – You must verify that the SWP is either at the construction office if the Site has one, or that the location of the SWP is posted.

- B. **If required, are the Applicable Permit and/or NOI on site?** – You must verify that the Applicable Permit and notification letter (if applicable) are on site if required under the Applicable Permit. Maintain a complete copy of the Applicable Permit in the SWP Binder.
- C. **Is contact information for the Site Storm Water Compliance Representatives provided on site and is it correct?** – You must verify that the name(s) and the phone number(s) of the Site Storm Water Compliance Representative(s) are located in a conspicuous place on site and are correct and legible.
- D. **Since that last inspection, has Toll Brothers received written notice of a federal, state, or local inspection evaluating compliance with the Applicable Permit?** - The notice contemplated by this question is written notice from a federal, state, or local entity regarding a storm water inspection evaluating compliance with the Applicable Permit (i.e., the NPDES or State equivalent storm water permit). Local inspections evaluating compliance with local programs (e.g. post-construction stormwater management of locally approved erosion and sediment control) do not require an answer of yes to this question. If, however, Toll has received written notice of a federal, state, or local inspection evaluating compliance with the Applicable Permit, you must record the name of the agency that performed the inspection, the name and the position of the person that performed the inspection for the agency, and the date of the inspection. Further, you must include on the Responsive Action Log a description of the Action Items that were identified on the federal, state, or local inspection.
- E. **Was the Site Inspection Report for the last inspection signed by the Site Storm Water Compliance Representative and certified if and as required by the Applicable Permit?** – You must verify that the Site Inspection Report for the prior inspection was signed and, if required under the Applicable Permit, verified by the person undertaking that inspection, whether that person was the Site Storm Water Compliance Designee or the Site Storm Water Compliance Representative. You must also verify the Site Storm Water Compliance Representative reviewed and signed the form if the Site Storm Water Compliance Designee conducted the Site Inspection.
- **Maintenance** - Assign a separate reference number to each Action Item identified within the following categories and briefly describe the Responsive Action required to address the Action Item.
- F. **Is there an excess of sediment or other pollutants exiting the site?** – You must verify that neither an excess of sediment nor an excess of other pollutants are exiting the site. You should check applicable BMPs such as outfalls, exit/entrance controls, site perimeter controls, receiving water courses and adjacent off-site areas for excessive sediment or other excessive pollutant discharges. You should determine and record the source of the excessive sediment or other pollutants. If an off-site property is discharging sediment or

pollutants onto the site, record that information and whether the off-site source is contributing to the excessive discharge from the site.

- G. **Are off-site roads/gutters free of excessive sediment from the site?** – You must verify that the roads adjacent to the site are free of excessive sediment. You should determine and record the source of the excessive sediment. If an off-site property is contributing to or causing the excessive sediment in the off-site roads or gutters, record that information.
- H. **Are exit/entrance controls properly located and in working condition, with no maintenance necessary?** – You must verify that exit/entrance controls are properly located, in working condition, and no repairs are necessary. You should check that exit/entrance controls, such as stone tracking pads, rumble grates, and related controls for the construction entrance and other access points are in place and are maintained pursuant to the SWP.
- I. **Are exposed areas stabilized as required?** – You must verify that exposed areas are stabilized, if and as required by the Applicable Permit. Exposed areas are any areas that have been disturbed or have otherwise lost natural cover. You should check that areas where construction activity has ceased or has been temporarily suspended are stabilized in accordance with the SWP.
- J. **Are stockpiles located and stabilized as required?** – You must verify that stockpiles are located and stabilized as required. You should check that stockpiles are located in areas where they may minimize the potential for discharging excessive sediment from the site or onto any road or gutter and that they have been stabilized in accordance with the SWP.
- K. **Are other BMPs properly located, in working condition, and no repairs necessary?** – You must verify that BMPs are properly located and in working condition and that no repairs are necessary. You should check that BMPs (including perimeter controls, soil stabilization techniques, sediment ponds/traps and inlet protection) are properly placed, appear to be working, and are maintained in accordance with the SWP.
- L. **Are concrete, paint, and stucco washout areas properly located, in working condition, and no maintenance necessary?** – You must verify that concrete, paint, and other washouts are properly placed, appear to be working, and are maintained in accordance with the SWP.
- M. **Are hazardous materials managed as required?** – You must verify that hazardous materials are managed as required. You should check that storage and containment areas and controls are implemented in accordance with the SWP, and confirm that hazardous materials are properly managed (no leaks or spills).
- N. **Are trash, construction debris, and other solid wastes managed as required; and on-site roads/gutters free of excessive sediment?** – You must verify that trash, construction debris, and other solid wastes are managed as required. You should check that controls for the collection and storage of

trash, construction debris, and other solid wastes are properly placed, appear to be effective, and are maintained in accordance with the SWP. You must verify that the on-site roads and gutters are free of excessive sediment.

- O. **Are portable toilets properly located and maintained?** – You must verify that portable toilets are provided and properly located. You should check that portable toilets are located off roads and away from gutters and inlets and are properly anchored and maintained.
  
- P. **Are the Site Storm Water BMPs and the SWP consistent with each other?** – You must verify that site BMPs and the SWP are consistent with each other. You should check that the BMPs shown on the SWP for the current stage of construction exist on site, and that the BMPs that exist on site are shown on the SWP. In particular, you must make sure that any map or figure within the SWP is consistent with what has been installed on the ground. Even if we have installed additional BMPs not originally called for in the SWP, the additional BMPs must be shown on the map.
  
- Q. **Are there ruts, gullies, or other signs of accelerated erosion?** – You must verify that there are no signs of accelerated erosion, including ruts or gullies. Be certain to check all unstabilized areas, slopes, and conveyance swales and ditches.
  
- R. **Are there any other compliance issues, inadequate BMPs, additional BMPs, or improvements this Site should address?** – You must verify that the Site is in compliance with other conditions of the Applicable Permit, and all BMPs are adequate and performing to the requirements of the SWP.

# USER INSTRUCTIONS FOR RAIN EVENT SITE INSPECTION REPORT

## GENERAL INSTRUCTIONS

This form is to be used when a NPDES Rain Event Inspection is required by the Applicable Permit. Do not use this form for Regularly Scheduled Inspections.

When a rain event occurs in conjunction with a regularly scheduled inspection (e.g. the community receives ½" of rain that ends less than 24 hours before the regularly scheduled inspection day), use the Regular Site Inspection Report.

This form will be used when a rain event occurs at all other times, including weekends.

- Within 24 hours of a rain event occurring, complete the Rain Event Site Inspection Report.
- Complete the Site Name, Inspection Area, Division, Inspection Date, Inspection Time, and Inspector's Name information at the top.
- List the Rainfall Amount received and the length of the storm (in hours) at the Site. Obtain the information from the on-site rain gauge, or from a weather information website for your location. Check the Pre-Storm box if you are performing an inspection in advance of a predicted rainfall event (currently only required by California).

## INSTRUCTIONS FOR COMPLETING INDIVIDUAL QUESTIONS

Walk through the entire construction area and look for signs of

1. pollutant discharges;
  2. excessive sediment on off-site roads and gutters;
  3. erosion control measures that may have failed or been damaged;
  4. ruts, gullies, or other signs of accelerated erosion;
  5. existing erosion control measures that are inadequate; and
  6. areas which require additional erosion control measures.
- You must respond to all of the following questions on each and every Rain Event Site Inspection Report.
    - F. **Is there an excess of sediment or other pollutants exiting the site?** – You must verify that neither an excess of sediment nor an excess of other pollutants are exiting the site. You should check applicable BMPs such as outfalls, exit/entrance controls, site perimeter controls, receiving water courses and adjacent off-site areas for excessive sediment or other excessive pollutant discharges. You should determine and record the source of the excessive sediment or other pollutants. If an off-site property is discharging sediment or pollutants onto the site, record that information and whether the off-site source is contributing to the excessive discharge from the site.

- G. **Are off-site roads/gutters free of excessive sediment from the site?** – You must verify that the roads adjacent to the site are free of excessive sediment. You should determine and record the source of the excessive sediment. If an off-site property is contributing to or causing the excessive sediment in the off-site roads or gutters, record that information.
- K. **Are other BMPs properly located, in working condition, and no repairs necessary?** – You must verify that BMPs are properly located and in working condition and that no repairs are necessary. You should check that BMPs (including perimeter controls, soil stabilization techniques, sediment ponds/traps and inlet protection) are properly placed, appear to be working, and are maintained in accordance with the SWP.
- Q. **Are there ruts, gullies, or other signs of accelerated erosion?** – You must verify that there are no signs of accelerated erosion, including ruts or gullies. Be certain to check all unstabilized areas, slopes, and conveyance swales and ditches.
- R. **Are there any other compliance issues, inadequate BMPs, additional BMPs, or improvements this Site should address?** – You must verify that the Site is in compliance with other conditions of the Applicable Permit, and all BMPs are adequate and performing to the requirements of the SWP.

## INSTRUCTIONS FOR COMPLETING THE RESPONSIVE ACTION LOG

- You must record each reference number on the Responsive Action Log in the first column under “Reference Number”. Each reference number must be listed on a separate line.
- For each reference number, you must identify in the “Action Item and Location” column the condition that requires action to be taken to achieve or maintain compliance with Storm Water Requirements, and give location information.
  - If a condition relates to a BMP, you must identify the applicable BMP by type and location and state the action necessary to achieve or maintain compliance with the SWP. If a condition relates to anything other than a BMP, you must briefly describe the condition that requires action and the action necessary to achieve or maintain compliance with the SWP.
- You must record the date the Action Item was first identified in the “Date Item Noted” column.
- The date recorded for a Responsive Action under the “Date Item Noted” column will not change, even if the Responsive Action is carried over to subsequent Responsive Action Logs. When a Responsive Action is restated or carried over to a new Responsive Action Log, you must restate or carry over the date for the Responsive Action as identified on the first Responsive Action Log on which the Responsive Action appeared.
- **The Site Storm Water Compliance Representative or the Storm Water Consultant Designee is responsible for recording the date each Responsive Action is corrected.** If the Site Storm Water Compliance Representative or the Storm Water Consultant Designee actually performed the Responsive Action, he or she should date the Responsive Action Log the same day as the Responsive Action is completed. If a Contractor performs the Responsive Action, the Site Storm Water Compliance Representative or the Storm Water Consultant Designee must confirm that the Responsive Action has been completed and record the date the Responsive Action was completed by the Contractor. The Site Storm Water Compliance Representative or the Storm Water Consultant Designee should record the individual or company that performed the Responsive Action in the “Addressed By” box.
- You must provide a description of the measures used to correct the Action Item in the column “Responsive Action Taken”.



# Construction Stormwater Site Inspection Form

**Project Name** \_\_\_\_\_ **Permit #** \_\_\_\_\_ **Inspection Date** \_\_\_\_\_ **Time** \_\_\_\_\_

Name of Certified Erosion Sediment Control Lead (CESCL) or qualified inspector if *less than one acre*  
 Print Name: \_\_\_\_\_

Approximate rainfall amount since the last inspection (in inches): \_\_\_\_\_

Approximate rainfall amount in the last 24 hours (in inches): \_\_\_\_\_

Current Weather   Clear    Cloudy    Mist    Rain    Wind    Fog

**A. Type of inspection:**      Weekly    Post Storm Event    Other

**B. Phase of Active Construction (check all that apply):**

Pre Construction/installation of erosion/sediment controls	<input type="checkbox"/>	Clearing/Demo/Grading	<input type="checkbox"/>
Concrete pours	<input type="checkbox"/>	Vertical Construction/buildings	<input type="checkbox"/>
Offsite improvements	<input type="checkbox"/>	Site temporary stabilized	<input type="checkbox"/>
		Infrastructure/storm/roads	<input type="checkbox"/>
		Utilities	<input type="checkbox"/>
		Final stabilization	<input type="checkbox"/>

**C. Questions:**

- |  |     |    |  |
|--|-----|----|--|
| 1. Were all areas of construction and discharge points inspected?  | Yes | No |  |
| 2. Did you observe the presence of suspended sediment, turbidity, discoloration, or oil sheen            | Yes | No |  |
| 3. Was a water quality sample taken during inspection? ( <i>refer to permit conditions S4 &amp; S5</i> ) | Yes | No |  |
| 4. Was there a turbid discharge 250 NTU or greater, or Transparency 6 cm or less?*                       | Yes | No |  |
| 5. If yes to #4 was it reported to Ecology?  | Yes | No |  |
| 6. Is pH sampling required? pH range required is 6.5 to 8.5.   | Yes | No |  |

If answering yes to a discharge, describe the event. Include when, where, and why it happened; what action was taken, and when.

\_\_\_\_\_

\_\_\_\_\_

\_\_\_\_\_

\*If answering yes to # 4 record NTU/Transparency with continual sampling daily until turbidity is 25 NTU or less/ transparency is 33 cm or greater.

Sampling Results: \_\_\_\_\_ Date: \_\_\_\_\_

Parameter	Method (circle one)	Result			Other/Note
		NTU	cm	pH	
<i>Turbidity</i>	tube, meter, laboratory				
<i>pH</i>	Paper, kit, meter				

# Construction Stormwater Site Inspection Form

D. Check the observed status of all items. Provide "Action Required" details and dates.

Element #	Inspection	BMPs Inspected			BMP needs maintenance	BMP failed	Action required (describe in section F)
		yes	no	n/a			
1 Clearing Limits	Before beginning land disturbing activities are all clearing limits, natural resource areas (streams, wetlands, buffers, trees) protected with barriers or similar BMPs? (high visibility recommended)						
2 Construction Access	Construction access is stabilized with quarry spalls or equivalent BMP to prevent sediment from being tracked onto roads?						
	Sediment tracked onto the road way was cleaned thoroughly at the end of the day or more frequent as necessary.						
3 Control Flow Rates	Are flow control measures installed to control stormwater volumes and velocity during construction and do they protect downstream properties and waterways from erosion?						
	If permanent infiltration ponds are used for flow control during construction, are they protected from siltation?						
4 Sediment Controls	All perimeter sediment controls (e.g. silt fence, wattles, compost socks, berms, etc.) installed, and maintained in accordance with the Stormwater Pollution Prevention Plan (SWPPP).						
	Sediment control BMPs (sediment ponds, traps, filters etc.) have been constructed and functional as the first step of grading.						
	Stormwater runoff from disturbed areas is directed to sediment removal BMP.						
5 Stabilize Soils	Have exposed un-worked soils been stabilized with effective BMP to prevent erosion and sediment deposition?						

## Construction Stormwater Site Inspection Form

Element #	Inspection	BMPs Inspected			BMP needs maintenance	BMP failed	Action required (describe in section F)
		yes	no	n/a			
5 Stabilize Soils Cont.	Are stockpiles stabilized from erosion, protected with sediment trapping measures and located away from drain inlet, waterways, and drainage channels?						
	Have soils been stabilized at the end of the shift, before a holiday or weekend if needed based on the weather forecast?						
6 Protect Slopes	Has stormwater and ground water been diverted away from slopes and disturbed areas with interceptor dikes, pipes and or swales?						
	Is off-site storm water managed separately from stormwater generated on the site?						
	Is excavated material placed on uphill side of trenches consistent with safety and space considerations?						
	Have check dams been placed at regular intervals within constructed channels that are cut down a slope?						
7 Drain Inlets	Storm drain inlets made operable during construction are protected.						
	Are existing storm drains within the influence of the project protected?						
8 Stabilize Channel and Outlets	Have all on-site conveyance channels been designed, constructed and stabilized to prevent erosion from expected peak flows?						
	Is stabilization, including armoring material, adequate to prevent erosion of outlets, adjacent stream banks, slopes and downstream conveyance systems?						
9 Control Pollutants	Are waste materials and demolition debris handled and disposed of to prevent contamination of stormwater?						
	Has cover been provided for all chemicals, liquid products, petroleum products, and other material?						
	Has secondary containment been provided capable of containing 110% of the volume?						
	Were contaminated surfaces cleaned immediately after a spill incident?						
	Were BMPs used to prevent contamination of stormwater by a pH modifying sources?						

## Construction Stormwater Site Inspection Form

Element #	Inspection	BMPs Inspected			BMP needs maintenance	BMP failed	Action required (describe in section F)
		yes	no	n/a			
9 Cont.	Wheel wash wastewater is handled and disposed of properly.						
10 Control Dewatering	Concrete washout in designated areas. No washout or excess concrete on the ground.						
	Dewatering has been done to an approved source and in compliance with the SWPPP.						
	Were there any clean non turbid dewatering discharges?						
11 Maintain BMP	Are all temporary and permanent erosion and sediment control BMPs maintained to perform as intended?						
12 Manage the Project	Has the project been phased to the maximum degree practicable?						
	Has regular inspection, monitoring and maintenance been performed as required by the permit?						
	Has the SWPPP been updated, implemented and records maintained?						
13 Protect LID	Is all Bioretention and Rain Garden Facilities protected from sedimentation with appropriate BMPs?						
	Is the Bioretention and Rain Garden protected against over compaction of construction equipment and foot traffic to retain its infiltration capabilities?						
	Permeable pavements are clean and free of sediment and sediment laden-water runoff. Muddy construction equipment has not been on the base material or pavement.						
	Have soiled permeable pavements been cleaned of sediments and pass infiltration test as required by stormwater manual methodology?						
	Heavy equipment has been kept off existing soils under LID facilities to retain infiltration rate.						

**E. Check all areas that have been inspected. ✓**

All in place BMPs  All disturbed soils  All concrete wash out area  All material storage areas   
 All discharge locations  All equipment storage areas  All construction entrances/exits

# Construction Stormwater Site Inspection Form

---

F. Elements checked "Action Required" (section D) describe corrective action to be taken. List the element number; be specific on location and work needed. Document, initial, and date when the corrective action has been completed and inspected.

Element #	Description and Location	Action Required	Completion Date	Initials

*Attach additional page if needed*

**Sign the following certification:**

"I certify that this report is true, accurate, and complete, to the best of my knowledge and belief"

Inspected by: (print) \_\_\_\_\_ (Signature) \_\_\_\_\_ Date: \_\_\_\_\_

Title/Qualification of Inspector: \_\_\_\_\_

## **E. Construction Stormwater General Permit (CSWGP)**

## F. 303(d) List Information

### Assessed Waters/Sediment

#### Water

- Category 5 - 303d
- Category 4C
- Category 4B
- Category 4A
- Category 2
- Category 1

#### Sediment

- Category 5 - 303d
- Category 4C
- Category 4B
- Category 4A
- Category 2
- Category 1

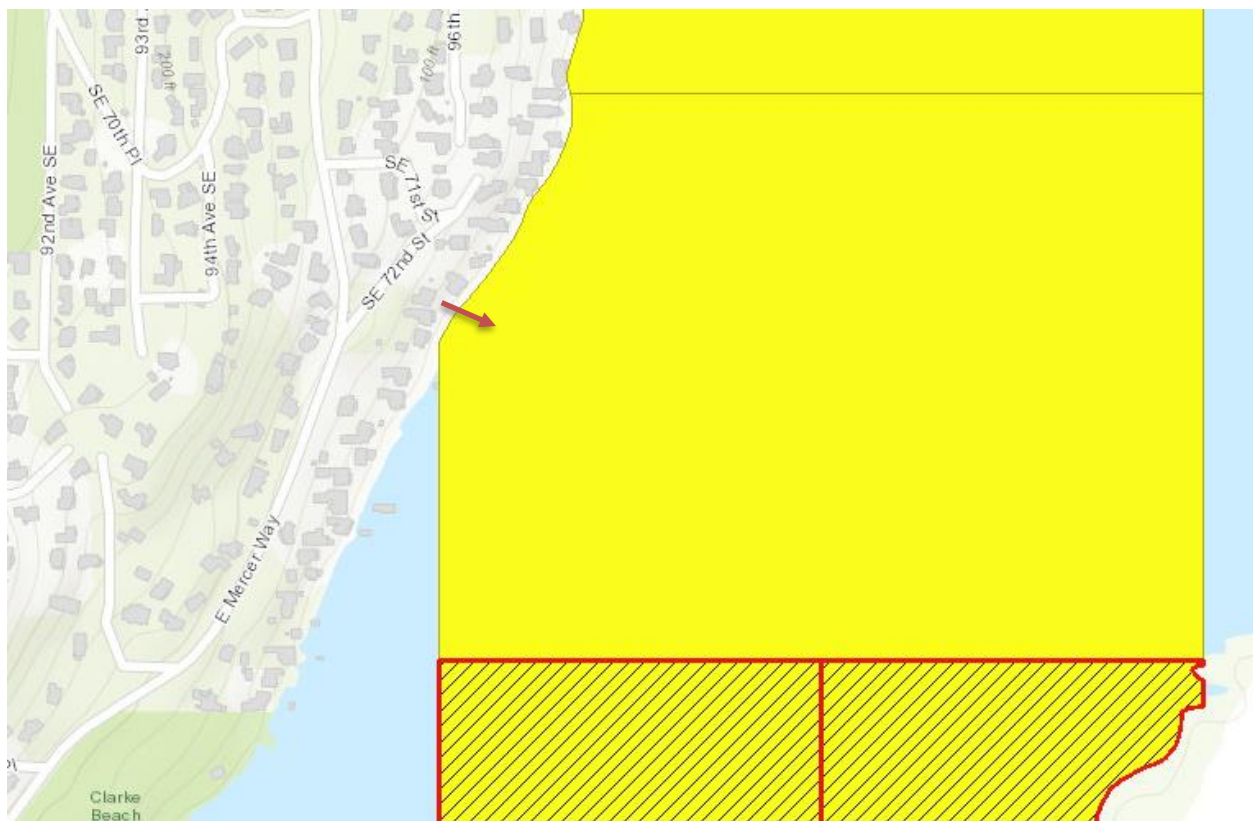

## Listing ID: 12311

### Main Listing Information

**Listing ID:** 12311 **Candidate Category:** 2 2  
**Waterbody Name:** WASHINGTON LAKE [View Category History](#)  
**Medium:** Water  
**Parameter:** Polychlorinated Biphenyls (PCBs)  
**WQI Project:** None  
**Designated Use:** Multiple - Harvesting & Domestic Water

### Assessment Unit

**Assessment Unit ID:** 47122F2D0\_01\_01 **County:** King  
**Size:** 0.723 Square kilometers **WRIA:** 8 - Cedar-Sammamish  
**Associated Components(s):** Grid: 47122F2D0, Type: Lakes (Full Grids)

### Basis Table

No Basis Table data.

### Basis Statement

#### HISTORICAL INFORMATION

King County unpublished data from station 840 show the National Toxic Rule criterion and the chronic criterion was exceeded on 8 August 2000.

### Remarks

Assessment Cycle 2018 - A historical Category 2 determination was carried forward from a previous assessment or administrative decision. See Historical Basis Statement for previous assessment information.

### Data Sources

No Source Records

### Map Link

[Map Link](#)

## Listing ID: 12200

### Main Listing Information

**Listing ID:** 12200 **Candidate Category:** 1 1  
**Waterbody Name:** WASHINGTON LAKE [View Category History](#)  
**Medium:** Water  
**Parameter:** Bacteria - Fecal coliform  
**WQI Project:** None  
**Designated Use:** Recreation - Primary Contact

### Assessment Unit

**Assessment Unit ID:** 47122F2D0\_01\_01 **County:** King  
**Size:** 0.723 Square kilometers **WRIA:** 8 - Cedar-Sammamish  
**Associated Components(s):** Grid: 47122F2D0, Type: Lakes (Full Grids)

### Basis Table

Sampling Year	Excursion Count	Sample Count	Criterion/Threshold	Aggregate	Calculated Value	Criterion 2	Aggregate 2	Calculated Value 2
2007	0	14	200 #col/100ml	Highest daily average	32	100 #col/100ml	Three-month geometric mean	20
2008	0	14	200 #col/100ml	Highest daily average	21	100 #col/100ml	Three-month geometric mean	6

### Basis Statement

#### HISTORICAL INFORMATION

Location ID: [KCM-0840] -- In water year 2005, 0 of 12 sample values (0%) showed an excursion of the % criterion for this waterbody (100 cfu/100mL). The geometric mean of 3.8 does not exceed the geometric mean criterion (50 cfu/100mL).

Location ID: [KCM-0840] -- In water year 2004, 0 of 9 sample values (0%) showed an excursion of the % criterion for this waterbody (100 cfu/100mL). The geometric mean of 3.5 does not exceed the geometric mean criterion (50 cfu/100mL).

King County unpublished data from station 840 show a geometric mean of 2 cfu/100mL with 0% exceeding the percentile criterion during 2002.

### Remarks

This listing previously contained E. coli data.

Designated Use change from Extraordinary Primary Contact Recreation to Primary Contact Recreation in 2019.

Assessment Cycle 2018 - During two water years (2007 and 2008), all calculated geometric means were below standards and there were geometric means in both the first and second halves of the year.

Data from Water Year 2007 show no exceedances of the percent or geometric mean criteria (At least 10 samples collected in one year).

### Data Sources

Study Id	Location Id	Source Database
<a href="#">KClake-1</a>	<a href="#">KCM-0840</a>	EIM

### Map Link



## Listing ID: 52862

### Main Listing Information

**Listing ID:** 52862  
**Waterbody Name:** WASHINGTON LAKE  
**Medium:** Water  
**Parameter:** Total Phosphorus  
**WQI Project:** None  
**Designated Use:** Aquatic Life - General

**Candidate Category:** 1 ■

[View Category History](#)

### Assessment Unit

**Assessment Unit ID:** 47122F2D0\_01\_01      **County:** King  
**Size:** 0.723 Square kilometers      **WRIA:** 8 - Cedar-Sammamish  
**Associated Components(s):** Grid: 47122F2D0, Type: Lakes (Full Grids)

### Basis Table

Sampling Year	Excursion Count	Sample Count	Criterion/Threshold	Aggregate	Calculated Value
2007	0	8	20 ug/L	Mean of daily averages	9
2008	1	8	20 ug/L	Mean of daily averages	9

### Basis Statement

#### HISTORICAL INFORMATION

Location ID [KCM-0840] -- In 2004 & 2005, the summer epilimnetic mean concentration of total phosphorus samples did not exceed the action value for this ecoregion, (20 ug/L).

### Remarks

Assessment Cycle 2018 - During two years (2007 and 2008), the arithmetic mean of samples collected June 1 through September 30 showed no exceedances of the criteria.

### Data Sources

Study Id	Location Id	Source Database
<a href="#">KClake-1</a>	<a href="#">KCM-0840</a>	EIM

### Map Link

[Map Link](#)

## Listing ID: 82896

### Main Listing Information

**Listing ID:** 82896  
**Waterbody Name:** WASHINGTON LAKE  
**Medium:** Water  
**Parameter:** Bacteria - Escherichia coli  
**WQI Project:** None  
**Designated Use:** Recreation - Primary Contact

**Candidate Category:** 1 ■

[View Category History](#)

### Assessment Unit

**Assessment Unit ID:** 47122F2D0\_01\_01      **County:** King  
**Size:** 0.723 Square kilometers      **WRIA:** 8 - Cedar-Sammamish  
**Associated Components(s):** Grid: 47122F2D0, Type: Lakes (Full Grids)

### Basis Table

Sampling Year	Excursion Count	Sample Count	Criterion/Threshold	Aggregate	Calculated Value	Criterion 2	Aggregate 2	Calculated Value 2
2007	0	14	320 #col/100ml	Highest daily average	26	100 #col/100ml	Three-month geometric mean	16
2008	0	14	320 #col/100ml	Highest daily average	12	100 #col/100ml	Three-month geometric mean	10

### Basis Statement

### Remarks

Assessment Cycle 2018 - During two water years (2007 and 2008), all calculated geometric means were below standards and there were no exceedances in both the first and second halves of the year.

### Data Sources

Study Id	Location Id	Source Database
<a href="#">KClake-1</a>	<a href="#">KCM-0840</a>	EIM

### Map Link

[Map Link](#)

## **G. Engineering Calculations**